

Operating instructions and spare parts list

OptiFeed PP05 Powder pump

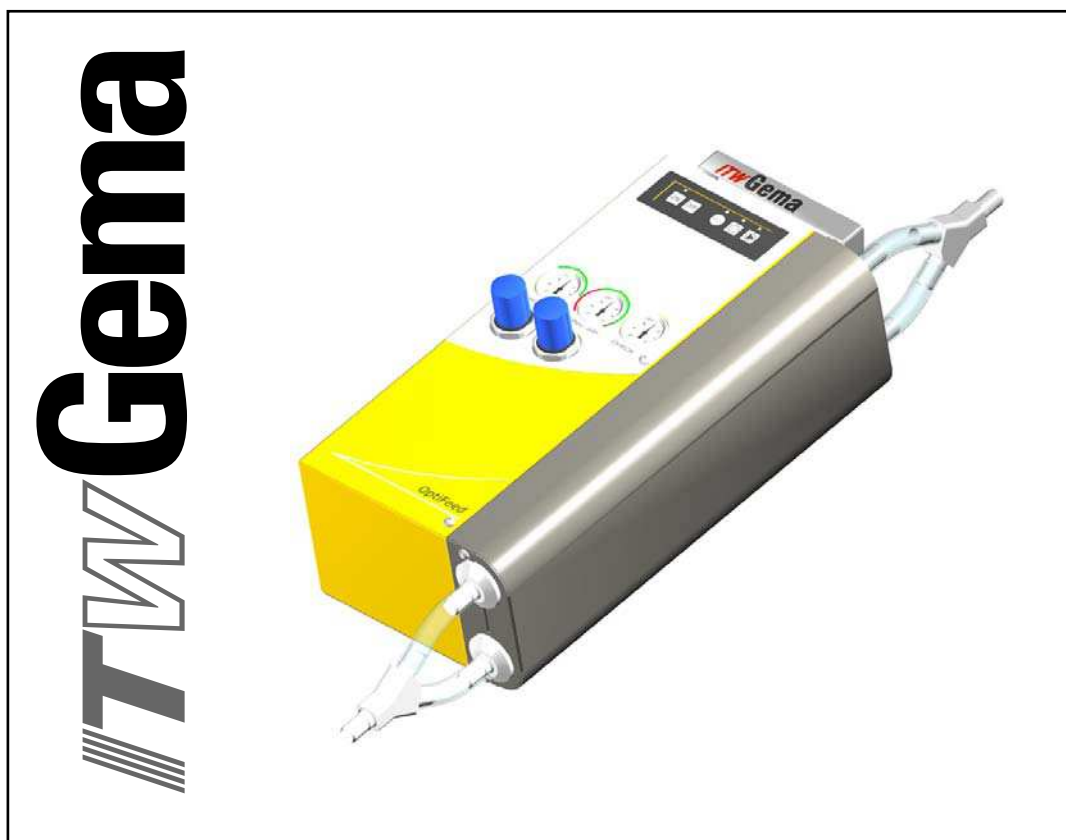

Translation of the original operating instructions

Documentation OptiFeed PP05 Powder pump

© Copyright 2006 ITW Gema GmbH

All rights reserved.

This publication is protected by copyright. Unauthorized copying is prohibited by law. No part of this publication may be reproduced, photocopied, translated, stored on a retrieval system or transmitted in any form or by any means for any purpose, neither as a whole nor partially, without the express written consent of ITW Gema GmbH.

OptiFlex, OptiTronic, OptiGun, EasyTronic, EasySelect, OptiFlow and SuperCorona are registered trademarks of ITW Gema GmbH.

OptiStar, OptiMatic, OptiMove, OptiMaster, OptiPlus, MultiTronic and Gematic are trademarks of ITW Gema GmbH.

All other product names are trademarks or registered trademarks of their respective holders.

Reference is made in this manual to different trademarks or registered trademarks. Such references do not mean that the manufacturers concerned approve of or are bound in any form by this manual. We have endeavored to retain the preferred spelling of the trademarks, and registered trademarks of the copyright holders.

To the best of our knowledge and belief, the information contained in this publication was correct and valid on the date of issue. ITW Gema GmbH makes no representations or warranties with respect to the contents or use of this publication, and reserves the right to revise this publication and make changes to its content without prior notice.

Printed in Switzerland

ITW Gema GmbH
Mövenstrasse 17
9015 St. Gallen
Switzerland

Phone: +41-71-313 83 00
Fax.: +41-71-313 83 83

E-Mail: info@itwgema.ch
Homepage: www.itwgema.ch

Table of contents

General safety regulations	5
Safety symbols (pictograms).....	5
Conformity of use.....	5
Product specific security measures	6
OptiFeed PP05 Powder pump	6
About this manual	7
General information	7
Software version	7
Function description	9
Field of application	9
OptiFeed PP05 Powder pump	9
Structure and function.....	10
OptiFeed PP05 Powder pump - structure.....	10
Powder hoses	10
OptiFeed PP05 Powder pump - functioning	11
Basic functions.....	12
Secondary functions	12
Technical data	13
OptiFeed PP05 Powder pump	13
Powder output (guide values)	13
Electrical data	13
Pneumatic data	13
Dimensions	14
Start-up and operation	15
Preparation for start-up	15
Basic conditions	15
Basic information	15
Connect the OptiFeed PP05 Powder pump.....	16
OptiFeed PP05 Powder pump - connections.....	17
Pin assignment	17
OptiFeed PP05 Powder pump - start-up.....	18
Connection and configuration	18
Powder fluidization.....	18
Connection possibilities and controls.....	19
Connection by the Control/PLC 2.4 connector	19
Control.....	19
Power IN 2.1 connection.....	19
Control.....	20
Connection with a connected level sensor	20
Control with level sensor and Control/PLC 2.4 or Power IN 2.1	20
OptiFeed PP05 Powder pump - operating elements	21
LEDs and input keys	21

OptiFeed PP05 Powder pump - characteristics	22
Conveying direction	22
Powder hose emptying/after-conveying	22
Powder hose rinsing	22
LM02 Level sensor - delay	23
Maintenance interval monitoring	23
Functional check and operation.....	24
Power supply by Power IN 2.1 connection (110-230 VAC).....	24
Power supply by Control/PLC 2.4 with occupied Power IN 2.1 connection (24 VDC).....	24
Manual switching on and off the conveying procedure on the pump control unit.....	24
Manual switching on and off the rinsing procedure on the pump control unit.....	25
External switching on and off the conveying procedure.....	25
External switching on and off the rinsing procedure	25
Operation with level sensor	26
External control - summary.....	26
OptiFeed PP05 Powder pump - shutdown	26
Setting the suction and conveying parameters	27
Setting the suction vacuum (VACUUM)	27
Setting the conveying air (CONV. AIR)	27
Procedure monitoring (CHECK).....	28
Special functions	29
Internal settings of the pump control unit	29
Miniature switch (DIP switch)	29
Setting the pump frequency (both conveying tubes).....	29
Setting the after-conveying in cycles (emptying the going-off powder hose).....	29
Powder hose emptying before powder supply	30
Timing-Diagram - Control/PLC 2.4 connection.....	30
Keyboard lock.....	30
Cleaning and maintenance	31
Cleaning the powder pump (color change)	31
Maintenance of the powder pump	31
Daily maintenance	31
Weekly maintenance	31
OptiFeed PP05 Powder pump - maintenance plan.....	32
Maintenance according to maintenance interval monitoring.....	32
Maintenance set	32
Changing the filter elements.....	33
Changing the pinch valves	33
Troubleshooting	35
General information	35
Schematic diagrams	39
OptiFeed PP05 - block diagram	39
OptiFeed PP05 - pneumatic diagram	40
Spare parts list	41
Ordering spare parts.....	41
OptiFeed PP05 Powder pump - pneumatic group.....	42
OptiFeed PP05 Powder pump - pneumatic group.....	43

OptiFeed PP05 Powder pump - pump control unit	44
OptiFeed PP05 Powder pump - pump control unit	45
OptiFeed PP05 Powder pump - powder chamber	46
OptiFeed PP05 Powder pump - powder chamber	47

General safety regulations

This chapter sets out the fundamental safety regulations that must be followed by the user and third parties using the OptiFeed PP05 Powder pump.

These safety regulations must be read and understood before the OptiFeed PP05 Powder pump is used.

Safety symbols (pictograms)

The following warnings with their meanings can be found in the ITW Gema operating instructions. The general safety precautions must also be followed as well as the regulations in the operating instructions.

**DANGER!**

Danger due to live electricity or moving parts. Possible consequences: Death or serious injury

**WARNING!**

Improper use of the equipment could damage the machine or cause it to malfunction. Possible consequences: minor injuries or damage to equipment

**INFORMATION!**

Useful tips and other information

Conformity of use

1. The OptiFeed PP05 Powder pump is built to the latest specification and conforms to the recognized technical safety regulations. It is designed for the normal application of powder coating.
2. Any other use is considered as non-conform. The manufacturer is not responsible for damage resulting from improper use of this equipment; the end-user alone is responsible. If the OptiFeed PP05 Powder pump is to be used for other purposes or other substances outside of our guidelines then ITW Gema GmbH should be consulted.
3. Observance of the operating, service and maintenance instructions specified by the manufacturer is also part of conformity of

use. The OptiFeed PP05 Powder pump should only be used, maintained and started up by trained personnel, who are informed about and are familiar with the possible hazards involved.

4. Start-up (i.e. the execution of a particular operation) is forbidden until it has been established that the OptiFeed PP05 Powder pump has been set up and wired according to the guidelines for machinery (98/37 EG). EN 60204-1 (machine safety) must also be observed.
5. Unauthorized modifications to OptiFeed PP05 Powder pump exempts the manufacturer from any liability from resulting damage.
6. The relevant accident prevention regulations, as well as other generally recognized safety regulations, occupational health and structural regulations are to be observed.
7. Furthermore the country-specific safety regulations must be observed.

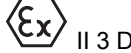
Explosion protection	Protection type	Temperature class
 	IP54	T6

Product specific security measures

- The installation work, to be done by the customer, must be carried out according to local regulations
- It must be observed, that all components are grounded according to the local regulations, before start-up

OptiFeed PP05 Powder pump

The OptiFeed PP05 Powder pump is a constituent part of the system and is thus integrated into the safety system of the plant.

For the use outside of the safety concept, corresponding measures must be taken.



Note:
For further information see the more detailed ITW Gema Safety regulations!

About this manual

General information

This operating manual contains all the important information which you require for the working with the OptiFeed PP05 Powder pump. It will safely guide you through the start-up process and give you references and tips for the optimal use of your new powder coating system.

Information about the function mode of the individual system components - reciprocators, booths, powder gun controls, powder guns etc. - should be referenced to their corresponding documents.

Software version

This document describes the operation of the OptiFeed PP05 Powder pump, with software version starting from 2.01!

Function description

Field of application

OptiFeed PP05 Powder pump

The OptiFeed PP05 Powder pump is intended for conveying coating powder (also enamel powder). Any other use is considered as non-conform. The manufacturer is not responsible for any damage resulting from this - the risk for this is assumed by the user alone!

The OptiFeed PP05 Powder pump is suitable both for conveying fresh powder to automatic coating plants, and for general conveying of coating powders from powder hoppers.



OptiFeed PP05 Powder pump

Structure and function

OptiFeed PP05 Powder pump - structure

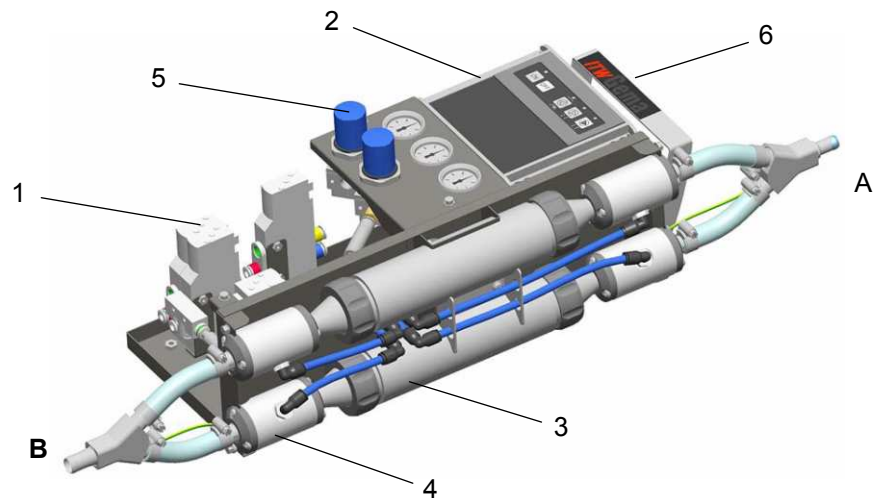

OptiFeed PP05 Powder pump - structure

A	Suction side	3	Powder chamber with filter elements
B	Transport side	4	Pinch valve
1	Pneumatic system	5	Pressure regulator
2	Pump control unit	6	Connections

Powder hoses

On the suction side, a powder hose with \varnothing 12/18 mm is connected and on the transport side, a powder hose with \varnothing 16/23 mm.

OptiFeed PP05 Powder pump - functioning

Suction procedure

In powder chamber 1, a vacuum (negative pressure) is produced. This vacuum aspirates the coating powder in the powder chamber. A fine-porous filter element (1) in the powder chamber separates the powder. The powder chamber is closed at the output side by a pinch valve (2).

Conveying procedure

The pinch valve (3) on the input side of the powder chamber 2 is closed, the pinch valve (4) on the output side is opened. The coating powder is pressed out of the powder chamber by overpressure, which is created with compressed air by the fine-porous filter element, and continued to convey.

The suction and the conveying procedure alternate between both powder chambers.

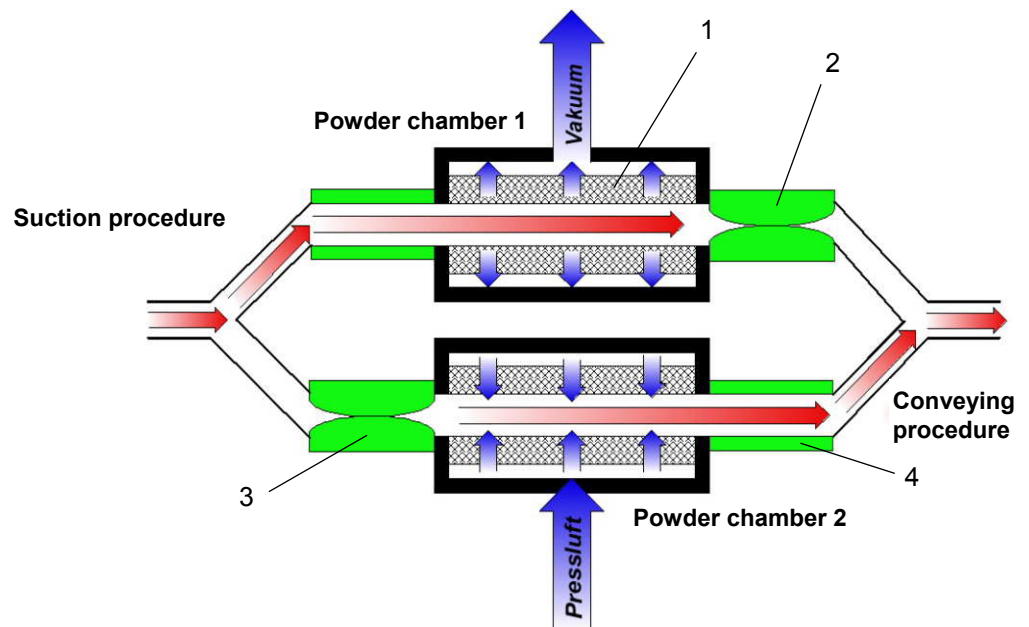

OptiFeed PP05 Powder pump - functioning

Basic functions

- Conveying of coating powders
- Receiving and processing of signals from the superordinated control unit (e.g. PLC)
- Controlling of a single phase vibrator motor
- Processing of signals from the LM02 Level sensor

Secondary functions

- Emptying of the powder hose - this prevents an unintended powder hose clogging (factory setting by miniature switch - number of pumping cycles without powder aspiration)
- Powder hose rinsing (two different programs) and cleaning of the filter elements - this can positively influence the color change procedure
- Maintenance interval monitoring - indicates an upcoming maintenance
- Keyboard lock - prevents an unmeant, manual intervention
- Fluidization connection
- Connection for electric conveying air pressure monitoring



Note:

The functions can be controlled manually or by an external, superordinated control unit!

Technical data

OptiFeed PP05 Powder pump

Powder output (guide values)

OptiFeed PP05 Powder pump	
Hose length up to 8 m	5 kg/min
Hose length 8-16 m	4 kg/min
Hose length 16-25 m	3.5 kg/min

Electrical data

OptiFeed PP05 Powder pump	
Nominal input voltage (without vibrator operation)	24 VDC
Nominal input voltage (with vibrator operation)	110/230 VAC
Frequency	50/60 Hz
Power	20 VA (without AUX)
Input power value AUX	100 VA
Protection type	IP54
Temperature range	10°C - 40°C (+32°F - +104°F)
Temperature class	T6

Pneumatic data

OptiFeed PP05 Powder pump	
Compressed air main connection	Quick release connection - 8 mm
Max. input pressure	8 bar
Min. input pressure	6 bar
Max. compressed air consumption	12 Nm ³ /h
Max. water vapor content of the compressed air	1.3 g/m ³
Max. oil vapor content of the compressed air	0.1 mg/m ³

Dimensions

OptiFeed PP05 Powder pump	
Length	550 mm
Width	255 mm
Height	209 mm
Weight	13.5 kg

Start-up and operation

Preparation for start-up

Basic conditions

By the start-up of the OptiFeed PP05 Powder pump, the following basic conditions, which have an influence on the powder transport, must be considered:

- Length and height difference of the suction distance
- Length of the conveying distance
- Powder preparation and powder quality
- Spatial arrangement of the OptiFeed PP05 Powder pump

Basic information

The adherence of the following principles leads to a successful start-up of the OptiFeed PP05 Powder pump:

- The suction distance is to be kept as short as possible
- The conveying distance should also be as short as possible. If the powder hose can be arranged wavy in plump line, then this is to be preferred to the horizontal arrangement (flat on the floor)
- At the suction area, a homogeneous fluidization must be ensured, so that no air ducts (crater) can be formed
- Basically, the powder transport with the OptiFeed PP05 Powder pump works with every powder type, which can be fluidized. If the powder is for example humid or contaminated with other materials, then the conveying can be negatively influenced or does not work at all
- A vertical arrangement of the OptiFeed PP05 Powder pump is to prefer to the horizontal arrangement, if possible (suction from above/conveying downwards)

Connect the OptiFeed PP05 Powder pump

The OptiFeed PP05 Powder pump is supplied ready for use by the manufacturer. Only a few cables and hoses must be connected.

The start-up takes place, depending on the powder pump control unit, according to following steps:

1. Connect the powder hoses to the powder pump input and output



Note:

The conveying in direction to the electrical and pneumatical connections is adjusted by factory!

The change of the conveying direction is described in the section "OptiFeed PP05 Powder pump - characteristics"!

2. Connect the fluidization to the connection **1.2** (if necessary)
3. Connect the compressed air supply to the connection **1.1**
4. Connect the pump operating voltage by **Control/PLC 2.4** or **Power IN 2.1**
5. If vibration is needed, connect the vibrator to the connection **AUX 2.2** in conjunction with connection **Power IN 2.1**



Note:

If a vibration motor is used on the AUX 2.2 connection, the power supply is always to be realized by the Power IN 2.1 connection! Optionally, a control can still take place by the Control/PLC 2.4 connection!

6. Connect the level sensor (if necessary)



Attention:

Not used connections are to be locked with the provided protection caps, so that no powder can attain to the electrical connections! In addition, make sure that not used pneumatical connections are also to be locked hermetically (if the fluidizing air is not used)! The closing is available by distribution, if the powder pump is delivered completely!

OptiFeed PP05 Powder pump - connections

Pin assignment



Power IN 2.1 connection

- 1 Neutral conductor N
- 2 Phase (100-240 VAC) P
- 3 Input "System" (100-240 VAC)
- PE Ground PE

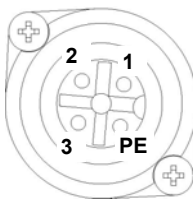

Connection AUX 2.2

- 1 Neutral conductor N
- 2 Vibration motor
- 3 Not used
- PE Ground PE



Connection Level Sensor 2.3

- 1 Ground
- 2 +24 VDC Level sensor
- 3 Signal (inverted)
- PE Ground PE



Connection Control/PLC 2.4

- 1 +24 VDC
- 2 Pumping (see chapter "Special functions")
- 3 Rinsing
- 4 +24 VDC output (max. loading 100 mA)
- 5 Keyboard lock
- 6 Ground
- PE Ground PE

OptiFeed PP05 Powder pump - start-up

Connection and configuration

The start-up of the OptiFeed PP05 Powder pump takes place according to following instructions:

1. Connect the compressed air supply (6-8 bar)
2. Connect the power supply 24 VDC (110-230 VAC with vibrator operation)
3. Ensure the grounding
4. Switch on the OptiFeed PP05 Powder pump
5. Check the pump control unit configuration (see therefore "Functional check and operation")
6. Adapt the adjusting parameters for suction procedure, suction distance and height (see also chapter "Setting the suction and conveying parameters")
7. Check the air supply for fluidization in the suction area
8. Start the pump procedure by pressing the **Pump** key
9. Optimize the adjusting parameters for the suction and conveying procedure



Note:

**It is recommended, to observe the pressure gauges of the pressure regulators. The displays should be in the green range!
The suction vacuum can be adjusted with more or less powder, the conveying air with more or less conveying air!**

Powder fluidization

The powder obtains a fluid-like consistency, so that a conveying can take place. This occurs by blowing air into the powder (fluidization). The fluidization takes place in a fluidized powder hopper, or locally around a suction lance, which aspirates the powder from a vibrated container.



Note:

For a better understanding of the interrelationships in powder coating, it is recommended to read completely the operating instructions of the other components, so as to be familiar with their functions too!

Connection possibilities and controls

Connection by the Control/PLC 2.4 connector

The OptiFeed PP05 Powder pump is supplied with an operating voltage of 24 VDC by the **Control/PLC 2.4** connector. This provides an opportunity, if no vibrator motor must be connected to the **AUX 2.2** connector, since for its operation, the mains voltage is missing. Optional connections are specified in *italic*.



Control

OptiFeed PP05 Powder pump	
+24 VDC on connection Pump of the Control/PLC 2.4 input	Pumping
+24 VDC on connection Rinsing of the Control/PLC 2.4 input	Powder hose rinsing
+24 VDC on connection Keyboard lock of the Control/PLC 2.4 input	<i>Local operation not allowed</i>



Note:

If the power supply takes place by the Control/PLC 2.4 connection, no vibration motor voltage is available on the AUX 2.2 connection!

Power IN 2.1 connection

If the OptiFeed PP05 Powder pump has to control a vibration motor, the connection by **Power IN 2.1** is mandatory, since a mains voltage is needed. The conveying can also be activated by the **Power IN 2.1** connection, by applying a mains voltage to the **System** connection of **Power IN 2.1**. Further functions are available by the **Control/PLC 2.4** connection. Optional connections are specified in *italic*.

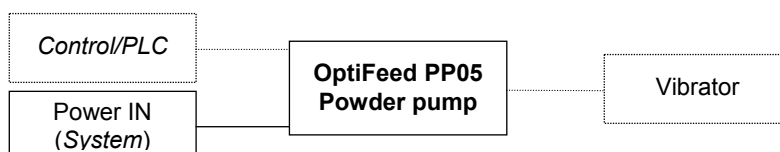

Control

OptiFeed PP05 Powder pump	
Mains voltage on the System connection of Power IN 2.1 input	Pumping
+24 VDC on connection Pump of the Control/PLC 2.4 input	<i>Pumping</i>
+24 VDC on connection Rinsing of the Control/PLC 2.4 input	<i>Powder hose rinsing</i>
+24 VDC on connection Keyboard lock of the Control/PLC 2.4 input	<i>Local operation not allowed</i>



Note:

If a vibrator is connected to the powder pump, the mains connection by Power IN 2.1 is necessary!

Connection with a connected level sensor

By connecting a level sensor on **Level Sensor 2.3**, the powder container level can be controlled with the powder pump.

If a level sensor is connected, a wake time can be activated/deactivated in the powder pump control unit. This wake time effects the after-conveying for 3 secs. after the achievement of the sensor switching point. This prevents the permanent switching on and off of the powder pump.

Optional connections are specified in *italic*.

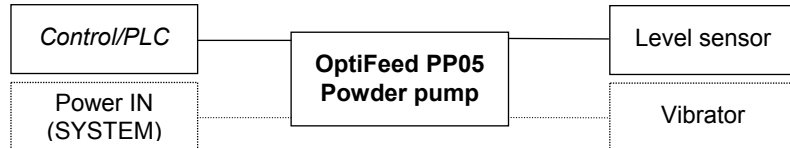

Control with level sensor and Control/PLC 2.4 or Power IN 2.1

OptiFeed PP05 Powder pump	
LM02 Level sensor signal by Level Sensor 2.3 connection	Pumping
<i>Mains voltage on System connection of the Power IN 2.1 input</i>	<i>Pumping</i>
+24 VDC on connection Pump of the Control/PLC 2.4 input	<i>Pumping</i>
+24 VDC on connection Rinsing of the Control/PLC 2.4 input	<i>Powder hose rinsing</i>
+24 VDC on connection Keyboard lock of the Control/PLC 2.4 input	<i>Local operation not allowed</i>

Level sensor connection cable

A level sensor connection cable is optionally available (see the "Pump control unit" spare parts list).



Level sensor connection cable

Pin number	Allocation
1	GND
2	24 VDC
3	Signal
PE	Shield

OptiFeed PP05 Powder pump - operating elements

LEDs and input keys

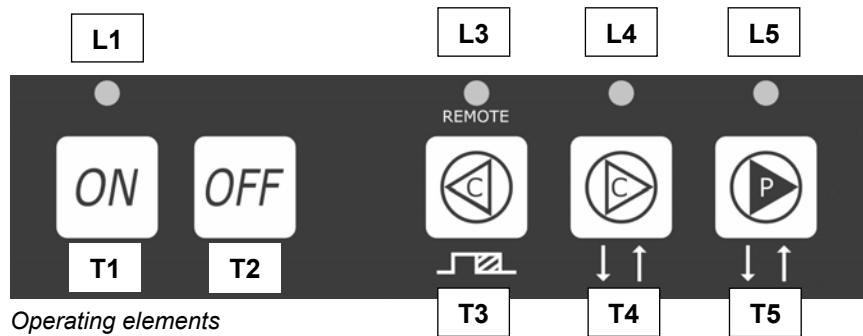

Operating elements

Designation	Function
L1	ON display
L3	Keyboard lock display
L4	Rinsing display
L5	Pump display
T1	ON key
T2	OFF key
T3	Rinsing/suction direction key
T4	Rinsing key
T5	Pump key

OptiFeed PP05 Powder pump - characteristics



Conveying direction

The conveying direction of the OptiFeed PP05 Powder pump is selected by factory in opposite direction of the connections (see picture). If the powder pump has to convey in the other direction (installation of the pump), the conveying direction can be changed.

To change the conveying direction, keep pressed the **Pump** key for 5 secs. when the equipment is switched on. After 5 secs. the **Pump** display blinks briefly.

By restarting the equipment, the new configuration is recognized.

Note:

By vertical position of the powder pump, the conveying direction must be set as adjusted by factory (suction side above/transport side below)!

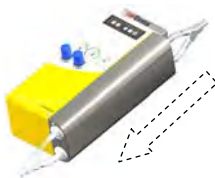

Powder hose emptying/after-conveying

The after-conveying avoids powder accumulations and blockages in the powder hose. If the after-conveying is activated, after terminating the pump procedure, a few predefined pumping cycles will be executed without aspirating powder (recommended for powder tube lengths of over 2 m). The powder hose will be emptied in this way, and blockages will be avoided. The after-conveying is activated by factory.

The after-conveying can be deactivated when using tube lengths under 2 m, so that little containers can not be filled over their target level.

Deactivate the after-conveying by pressing the **T3** key (rinsing/suction direction) for 5 secs. when the equipment is switched on. After 5 secs. the LED **L3** blinks briefly.

By restarting the equipment, the new configuration is recognized.



Powder hose rinsing

The powder hose rinsing allows the cleaning of the powder hoses and the filter elements in the powder pump. If color changes take place, rinsing must be done in conveying and in suction direction.

Manual rinsing for color change preparation

Rinsing in conveying direction is activated by pressing the **T4** key.

Rinsing in suction direction is activated by pressing the **T3** key.

Automatic rinsing for color change preparation

By activating the automatic rinsing function by an ext. control unit (Control/PLC), the suction side and the transport side are alternating rinsed automatically.



Attention:

Large dust formation possible!

Automatic rinsing for color change preparation

By activating the automatic rinsing function by an ext. control unit (Control/PLC), the powder pump is rinsed automatically. Two rinsing programs are available:

- Rinsing program 1 (rinsing preset by factory of both powder chambers with an external valve or with a compressed air gun)
- Rinsing program 2 (configurable rinsing in suction and conveying direction). The activation and deactivation takes place by pressing the **T3**, **T4** and **T5** keys at the same time for 5 secs. The LEDs **L3** and **L5** blink briefly

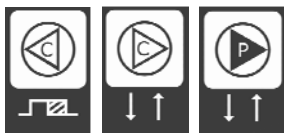

Attention:
Large dust formation possible!

Change the powder hose rinsing direction

Change the powder hose rinsing by pressing the **T4** key (rinsing) for 5 secs. when the equipment is switched on. After 5 secs. the LED **L4** blinks briefly.

By restarting the equipment, the new configuration is recognized.



LM02 Level sensor - delay

When connecting the LM02 Level sensor, the internal delay in the pump control unit can be deactivated.

The level sensor delay effects, that the conveying procedure does not switch on and off continuously after the achievement of the level sensor switching point. Therefore the conveying works a little longer, so that the sensor level will be exceeded.

Deactivate the delay by pressing the **T4** and **T5** keys at the same time for 5 secs. when the equipment is switched on. After 5 secs. the **ON** display blinks briefly.

By restarting the equipment, the new configuration is displayed.

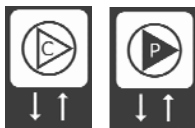

Maintenance interval monitoring

In order to offer an assistance to the user, the OptiFeed PP05 Powder pump indicates an upcoming maintenance. By stopping the pumping procedure, blinking LEDs (**L1**, **L3**, **L4**, **L5**) indicate an upcoming maintenance. The function of the OptiFeed PP05 Powder pump is not affected thereby!

Reset of the maintenance interval monitoring

After the maintenance has been carried out, the maintenance interval monitoring is reset by pressing the **T3** and **T4** keys at the same time for 5 secs. After 5 secs. the **ON** display blinks briefly.

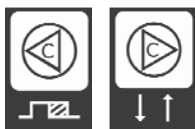

Functional check and operation



Note:

When assembly or a first start-up takes place, it is recommended to carry out the function check without powder!

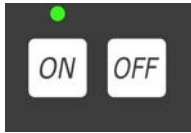

Power supply by Power IN 2.1 connection (110-230 VAC)

Switch on the OptiFeed PP05 Powder pump by pressing the **ON** key, the LED of the **ON** key illuminates. The OptiFeed PP05 Powder pump is ready for operation.



Power supply by Control/PLC 2.4 with occupied Power IN 2.1 connection (24 VDC)

The OptiFeed PP05 Powder pump operating voltage is provided and switched on by the external control unit. Herewith, the equipment is switched on by a present operating voltage by this external connection. The illuminated LED on the **ON** key indicates that the OptiFeed PP05 Powder pump is ready for operation.



Attention:

If a vibrator is connected, the equipment main switch must be switched on and the Power IN 2.1 connection must be occupied!



Note:

By applying the power supply on Control/PLC 2.4 or operating the power switch with connected power supply on Power IN 2.1, depending upon the configuration of the equipment, the LED L1, L3, L4 and L5 illuminate for 1 sec!

More detailed information is found in section "Connection possibilities and controls"!

Manual switching on and off the conveying procedure on the pump control unit



By pressing the **Pump** key, the conveying procedure will be started in the predefined conveying direction (for changing the conveying direction, see "OptiFeed PP05 Powder pump - characteristics"). During the conveying procedure, the **Pump** LED illuminates permanently.

By pressing the **Pump** key again, the conveying procedure will be terminated. If the after-conveying is activated, the hose is emptied in going-off direction of the pump (see also section "Special functions"). The **Pump** LED blinks during the after-conveying, then it expires.

Manual switching on and off the rinsing procedure on the pump control unit



By pressing the **Rinsing** key, the rinsing procedure will be started.

By manually rinsing, the **Rinsing** key LED illuminates during the rinsing procedure.

The procedure is terminated by pressing the **Rinsing** key again. The **Rinsing** LED expires.



Note:

If the "Pumping" or "Rinsing" functions were activated locally on the equipment, the rinsing procedure is not affected by external signals (switching off, switching functions etc.)!

External switching on and off the conveying procedure

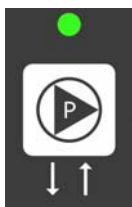

By external control of the pumping procedure, the **Pump** display and the **Keyboard lock** display illuminate, this indicates an external operation.

By switching off the external **Pumping** signal, the conveying procedure is terminated and the hose is emptied in going-off direction of the pump, if the after-conveying is activated (see also section "Special functions"). The **Pump** LED blinks during the after-conveying, then it expires. The conveying procedure can also be terminated by pressing the **Pump** key.



Note:

The after-conveying time is preset by factory! Therewith, it will be ensured that the powder hoses are emptied. The after-conveying time can be switched off when conveying distances are short, if the conveying distances are long, the after-conveying time can be extended. For further information, see in section "OptiFeed PP05 Powder pump - characteristics"!

External switching on and off the rinsing procedure

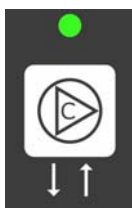

The rinsing procedure is started by the external **Rinsing** command. The **Rinsing** and **Keyboard lock** LEDs (external control) are illuminated during the rinsing procedure.

The procedure is terminated when the **Rinsing** signal is ending. The **Rinsing** LED expires.

The rinsing procedure can also be terminated by pressing the **Rinsing** key.



Note:

The rinsing procedure is intended for the preparation of a manual cleaning! In addition, the filter elements will be cleaned!



Note:

If the rinsing procedure - released by an external signal - is interrupted with the "Pump" or "Rinsing key", the "Keyboard lock" LED illuminates until the corresponding external signal changes its condition! Only then, another local or external command can be accepted!



Note:

In case of a simultaneous apply of the external signals "Pumping" and "Cleaning", a pumping in the opposite direction (back-pumping) takes place!
The blowing off direction can be adjusted by parameterization to the reverse pumping direction!

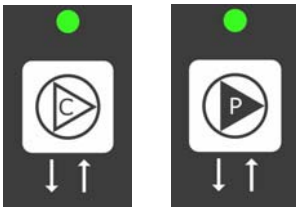

Operation with level sensor

The LM02 Level sensor is connected by default with an internal delay of the pump control unit. This delay can be deactivated (see section "LM02 Level sensor - delay"). During the delay time, the **Pumping** and **Rinsing** LEDs are blinking simultaneously.

External control - summary

"Pumping", "Level sensor" or "System" input	"Rinsing" input	Function
0	0	
1	0	Pumping
0	1	Rinsing
1	1	Back-pumping

OptiFeed PP05 Powder pump - shutdown

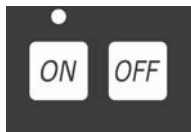

Switch off the OptiFeed PP05 Powder pump by pressing the **OFF** key, or by switching off on the external control unit. The LED on the **ON** key expires.

The compressed air supply to the powder pump must also be interrupted!

Setting the suction and conveying parameters

The parameterization of the OptiFeed PP05 Powder pump takes place with two pressure regulators (CONV. AIR and VACUUM). The following parameters can be set with the pressure regulators:

- Suction vacuum for the suction procedure
- Conveying air for the conveying procedure

Setting the suction vacuum (VACUUM)



The desired suction vacuum can be set by adjusting the **VACUUM** pressure regulator. The presetting by factory is 3 bar. Here are some recommended guide values:

Setting (bar)	Height difference (m)
2	0-1
3	2
4	3

Setting the conveying air (CONV. AIR)



The conveying air can be set by adjusting the **CONV. AIR** pressure regulator. The presetting by factory is 3 bar.

Recommendation:

- Do not fall below 2 bar, this can lead to cloggings
- Do not exceed 5 bar, if possible

Setting (bar)	Hose length (m)
2.0	up to 2
3.0	2-8
4.0	8-16
5.0	from 16

Guide values for the conveying adjustment

Option	Suction distance	Conveying distance	Suction vacuum (VACUUM)	Conveying air (CONV. AIR)	Powder hose emptying activated
1	2 m	5 m	2 bar	3 bar	yes, recommended
2	2 m	25 m	2 bar	5 bar	yes, recommended
3	6 m	5 m	4 bar	3 bar	yes, recommended
4	6 m	25 m	4 bar	5 bar	yes, recommended
5	2 m	2 m	2 bar	2 bar	not necessary



Procedure monitoring (CHECK)

The **CHECK** pressure gauge enables the procedure monitoring. The indicated value remains stable, if the procedures proceed perfectly. If the powder hose tends to clogging, then the pressure increases noticeably!

Note:

By correct functioning, i.e. the OptiFeed PP05 Powder pump is normally supplied with powder, a pressure peak between 0,3-0,8 bar should be generated!

On pumping process, the pressure may not exceed over 1 bar!

Special functions

Internal settings of the pump control unit

Miniature switch (DIP switch)

The setting values for **pump frequency** and **number of cycles** of the after-conveying can be changed with two miniature switches (DIP switches) within the given ranges.

Setting the pump frequency (both conveying tubes)

The pump control unit must be opened for this adjustment.

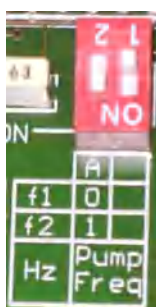

Miniature switch A	Frequency (Hz)
0	1.6
1	1.0

The factory settings are printed in **bold**

Setting the after-conveying in cycles (emptying the going-off powder hose)

The pump control unit must be opened for this adjustment.



Miniature switch A	Miniature switch B	Cycles
0	0	4
1	0	8
0	1	12
1	1	16

The factory settings are printed in **bold**

Powder hose emptying before powder supply

An external starting impulse permits a powder hose emptying before the powder supply starts. When the signal is ending, the pump stops without overtravel cycle.

Timing-Diagram - Control/PLC 2.4 connection

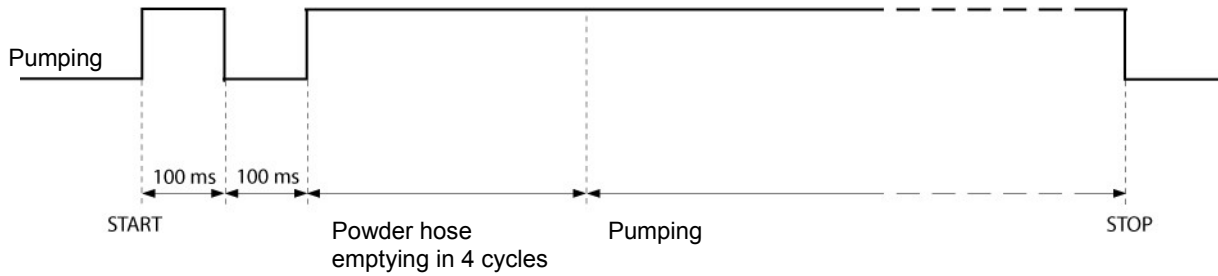

Timing-Diagram - Control/PLC 2.4 connection

Keyboard lock



If the keyboard lock is activated by an external control unit, the **Remote** display illuminates constantly. No local operation is possible (not the shutdown of the current pumping or rinsing procedure either).

The keyboard lock is released by applying 24 VDC on pin 5 of **Control/PLC 2.4**.

Cleaning and maintenance



Note:

Regular and conscientious maintenance increases the service life of the OptiFeed PP05 Powder pump and ensures a longer, more constant coating quality!

The parts, which are to be replaced during maintenance work, are available as spare parts. These parts will be found in the corresponding spare parts list!

Cleaning the powder pump (color change)

For the preparation of a color change, the pump has to be rinsed in conveying direction and in suction direction. As described, the rinsing procedure can be started and stopped manually or externally.

Maintenance of the powder pump

The OptiFeed PP05 Powder pump is designed in such a way, that only a minimum maintenance must be carried out.

Daily maintenance

Clean the powder pump with a dry cloth and check the connection points of the powder hoses. Replace the powder hoses, if necessary.

Weekly maintenance

Rinse the powder pump in conveying direction and in suction direction by using the rinsing program. Therewith, the filter elements are cleaned and possible, unintended powder deposits in the powder pump and in the powder hoses are avoided.

OptiFeed PP05 Powder pump - maintenance plan

The Pinch valves of the OptiFeed PP05 Powder pump are subject to a maintenance plan.



Attention:

A worn pinch valve hose, which becomes powder permeable, can damage the air valves!

Filter elements

The service life of the filter elements depends on the service duration, the powder quality and the quality of the air supply. Basically, it is recommended to replace also the filter elements by changing the pinch valves.

Maintenance according to maintenance interval monitoring

The OptiFeed PP05 Powder pump indicates an upcoming maintenance after approx. 1900 h of operating time. As guide value, following service durations are applied:

- by 1 shift operation - after 360 days (continuous operation)
- by 3 shift operation - after 120 days (continuous operation)

Maintenance set

The wear parts to be replaced during the PP05 Powder pump maintenance are available as maintenance set (see the spare parts list). This set contains 2 filter elements, 4 O-rings (Ø 30 mm), 4 O-rings (Ø 42 mm) and 4 pinch valve hoses.

Changing the filter elements

Required spare parts - 2 filter elements 40/30

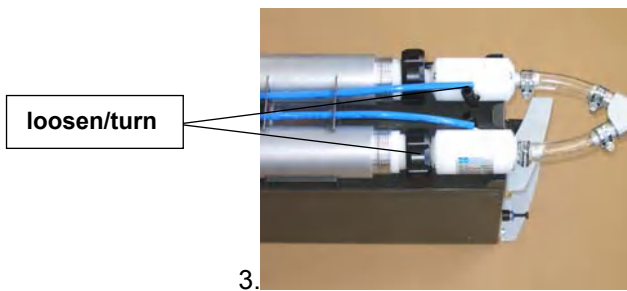
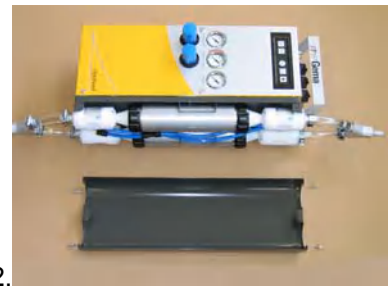

Note:
 The assembly takes place in reverse order!

Changing the pinch valves

Required spare parts - 4 pinch valve hoses NW15



Replace

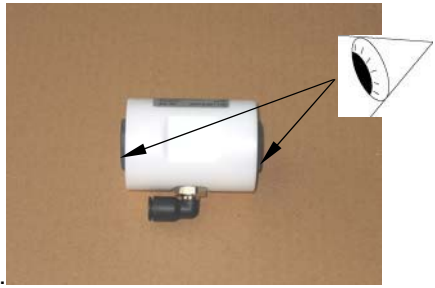

Soapy water

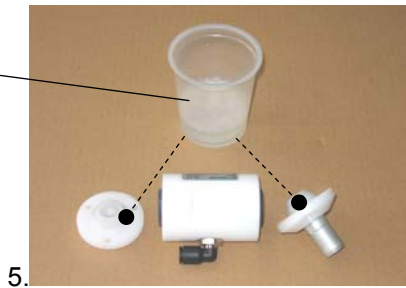

Tighten the screws evenly on both sides!



PTFE tape

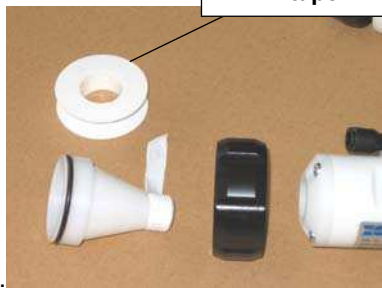

Troubleshooting

General information

Error	Causes	Troubleshooting
Display Ready for use on the pump control unit does not illuminate	Operating voltage is missing Internal or external fuse is defective	Check the power supply (110-240 VAC on connector 2.1 or +24 VDC on PIN 1 of connector 2.4) Replace the defective fuse
Powder pump does not convey, display Pumping does not illuminate	Operating signal Pumping on is missing	Check the control signal Check the power supply (+24 VDC on PIN 2 of connector 2.4 or 110-240 VAC on System input of connector 2.1)
Powder pump does not convey, display Pumping illuminates	If the LEDs on the valve plugs do not illuminate, the pump control unit is defective	Replace the pump control unit
Powder pump does not convey, display Pumping illuminates	If the LEDs on the valve plugs illuminate, the valve which nevertheless does not switch, is defectively	Replace the defective valve

Error	Causes	Troubleshooting
Powder pump does not convey	<p>Compressed air supply failed or pressure too low</p> <p>Fluidization in the suction in zone does work</p> <p>Conveying hose is clogged</p> <p>Suction hose is clogged</p> <p>Suction line is clogged</p> <p>Service life of the pinch valve runs off (defective)</p>	<p>Check the compressed air source (ensure an air pressure of 6-8 bar)</p> <p>Ensure the fluidization</p> <p>Change the suction direction, empty the powder hose until 6 m length (press the T5 key for 5 secs. and LED L5 blinks) - reset is identical</p> <p>Empty the powder hose over 6 m length with compressed air or manually (Attention - powder output in suction direction!)</p> <p>Run the rinsing program in conveying and in suction direction (Attention - powder output in suction direction!)</p> <p>Check the suction line, clean, ensure sealed transitions</p> <p>Change the pinch valve, check the pneumatic system for defects and replace, if necessary</p>

Error	Causes	Troubleshooting
Powder pump conveys irregularly or too little powder	<p>Scratch development in the powder container</p> <p>Filter elements tend to clogging</p> <p>Suction vacuum set incorrectly</p> <p>Conveying air set incorrectly</p> <p>Powder hoses tend to clogging due to sinterings</p> <p>The gaskets in the powder chambers are defective</p> <p>Oil or water in the system</p> <p>Suction line and its transition to the powder hose is leaking</p> <p>Discharges influence the control unit negatively</p> <p>Filter elements are completely clogged</p>	<p>Prevent scratch development by better fluidization or vibration, if possible</p> <p>Run the rinsing program in conveying and in suction direction, replace the filter elements</p> <p>Set correctly the suction vacuum (see "Setting the suction and conveying parameters")</p> <p>Set correctly the conveying air (see "Setting the suction and conveying parameters")</p> <p>Clean or replace the powder hoses</p> <p>Check the seating or the presence of the two O-rings</p> <p>Ensure that oil or water will be separated before entering into the powder pump</p> <p>Verify, check the gasket</p> <p>Check the grounding of the powder pump</p> <p>Run the rinsing program in conveying and in suction direction, replace the filter elements</p>
Too strong dust generation on the powder hose exit	Conveying air is too high	<p>Reduce gradually the conveying air.</p> <p>Attention - if the conveying air is too low, a clogging in the powder hose can occur</p>
Powder pump does not run the rinsing program, equipment indicates ready status	Operating signal Rinsing procedure is missing	Check control signal (+24 VDC on PIN 3 of connector 2.4)
Equipment is pumping in wrong direction	Equipment is not correctly parameterized	Parameterize correctly the conveying direction

Error	Causes	Troubleshooting
Equipment is pumping in wrong direction by external control	Pumping and Cleaning signals are not released at the same time	Check the Pumping and Cleaning signals (+24 VDC on PIN 2 and PIN 3 of connector 2.4)
Wrong blowing off direction	Equipment is not correctly parameterized	Parameterize correctly the blowing off direction
No after-conveying	Equipment is not correctly parameterized	Activate the after-conveying with parameterization
Wrong delay time by level sensor operation	Equipment is not correctly parameterized	Parameterize correctly the delay time
Equipment cannot be operated by the keys	Keyboard lock activated	Check the control signal of the keyboard lock (+24 VDC on PIN 6 of connector 2.4)

Schematic diagrams

OptiFeed PP05 - block diagram

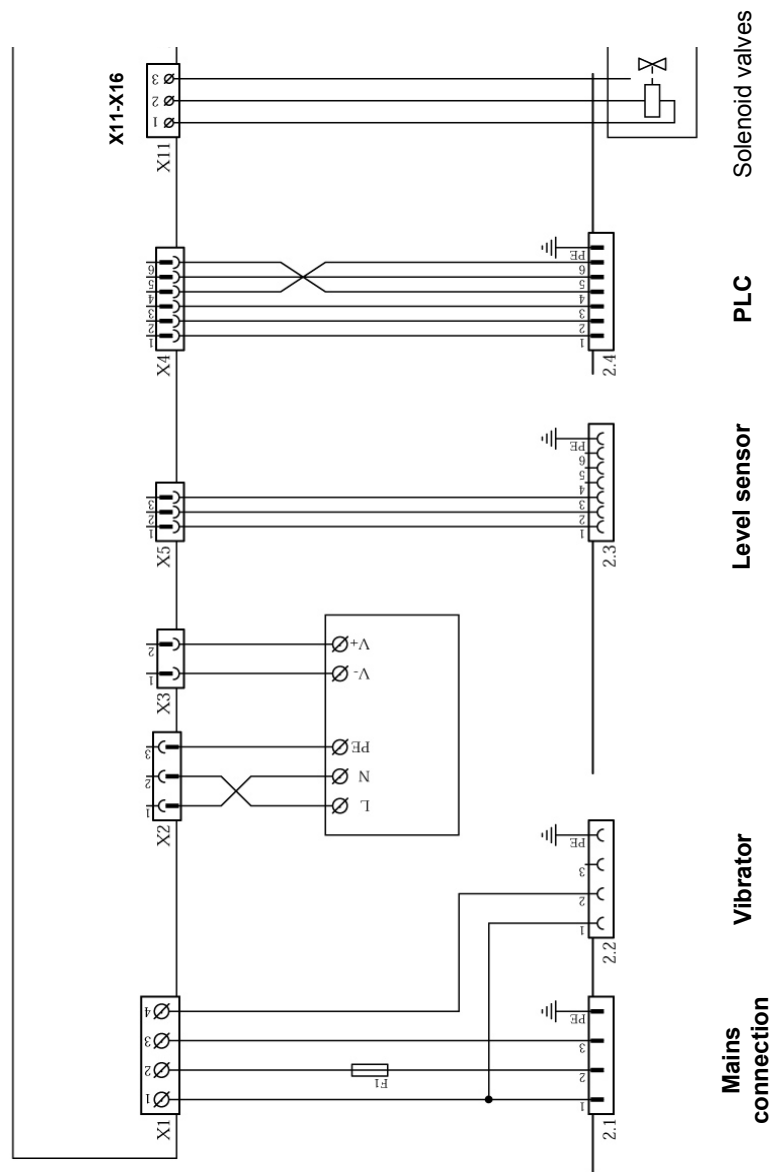

OptiFeed PP05 - block diagram

OptiFeed PP05 - pneumatic diagram

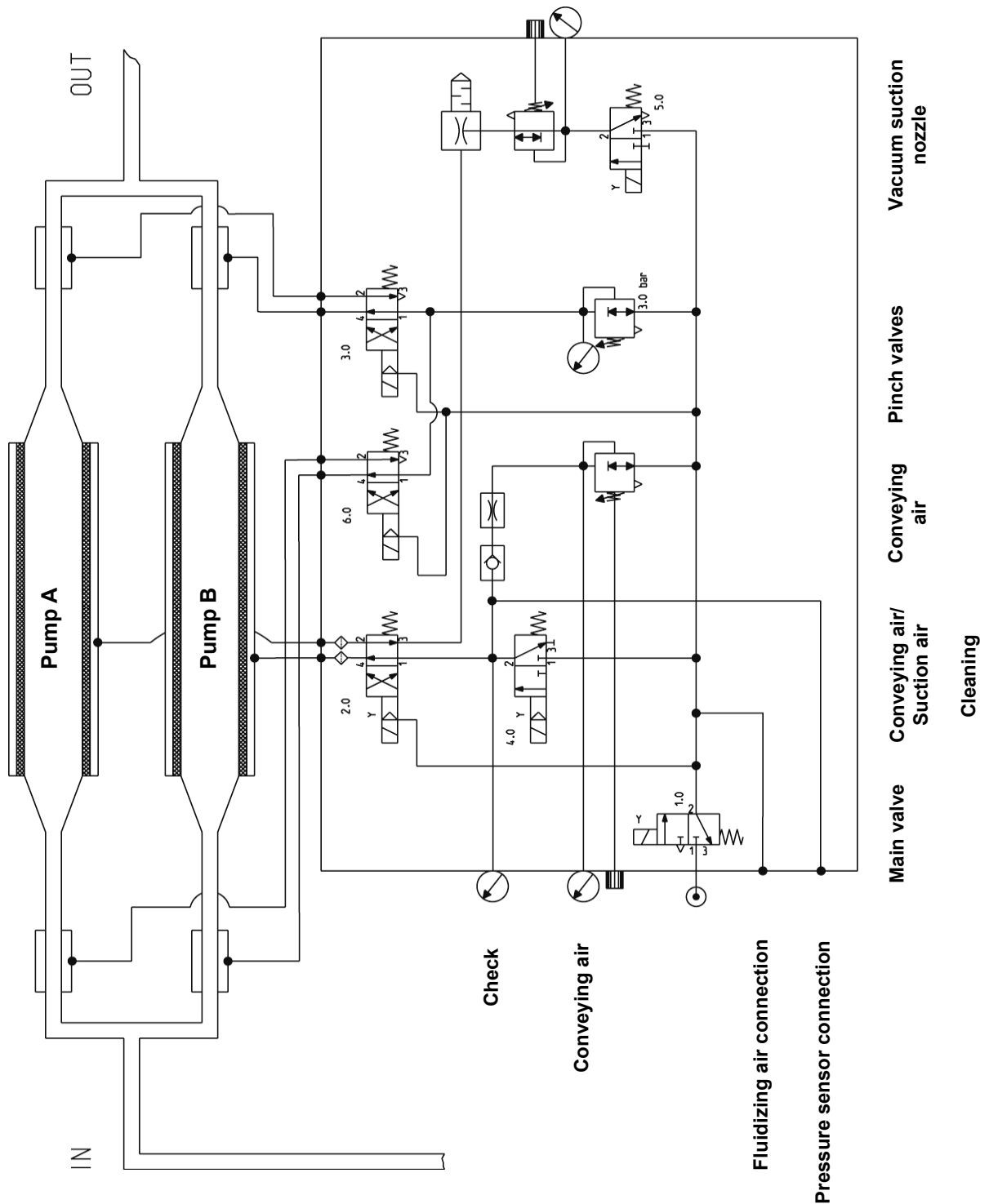

OptiFeed PP05 - pneumatic diagram

- | | |
|--|---|
| 1.0 Solenoid valve, 3/2 way NC, main valve | 4.0 Solenoid valve, 3/2 way NC, cleaning |
| 2.0 Solenoid valve, 4/2 way 24V, conv. air/suction air | 5.0 Solenoid valve, 3/2 way NC, vacuum nozzle |
| 3.0 Solenoid valve, 4/2 way 24V, pinch valve | 6.0 Solenoid valve, 4/2 way NC, pinch valve |

Spare parts list

Ordering spare parts

When ordering spare parts for powder coating equipment, please indicate the following specifications:

- Type and serial number of your powder coating equipment
- Order number, quantity and description of each spare part

Example:

- **Type** OptiFeed PP05 Powder pump
Serial number 1234 5678
- **Order no.** 203 386, 1 piece, Clamp - Ø 18/15 mm

When ordering cable or hose material, the required length must also be given. The spare part numbers of this yard/meter ware is always marked with an *.

The wear parts are always marked with a #.

All dimensions of plastic hoses are specified with the external and internal diameter:

Example:

Ø 8/6 mm, 8 mm outside diameter (o/d) / 6 mm inside diameter (i/d)



WARNING!

Only original ITW-Gema spare parts should be used, because the hazardous location approval will be preserved that way! The use of spare parts from other manufacturers will invalidate the ITW Gema guarantee conditions!

OptiFeed PP05 Powder pump - pneumatic group

	OptiFeed PP05 Powder pump - complete, with parts set, without powder hose	1003 122
	Pneumatic group - complete	1003 051
1	Pressure regulator	1003 291
2	Pressure gauge - 0-6 bar	1003 300
3	Hexagon nut	1003 292
4	3/2-way valve	1003 294
5	4/2-way valve	1003 293
6	Vacuum suction nozzle	1003 296
7	Check valve	1003 298
8	Mounting bracket	1003 295
9	Compressed air distributor - 6P	1002 693
10	Silencer	1003 299
11	Silencer - 1/4"a	252 115
12	Schott lead-through connection - Ø 8/8 mm	253 880
13	Plug - Ø 8 mm	238 023
14	Bezel - A=1.4 mm	404 497
15	Pressure sensor holder	1004 341
16	Plug cap - 1/2"a	1004 203
17	Screw-in nipple - 1/4"a-Ø 8 mm	265 136
18	Vacuum filter - Ø 8 mm, Inline	1004 946

OptiFeed PP05 Powder pump - pneumatic group

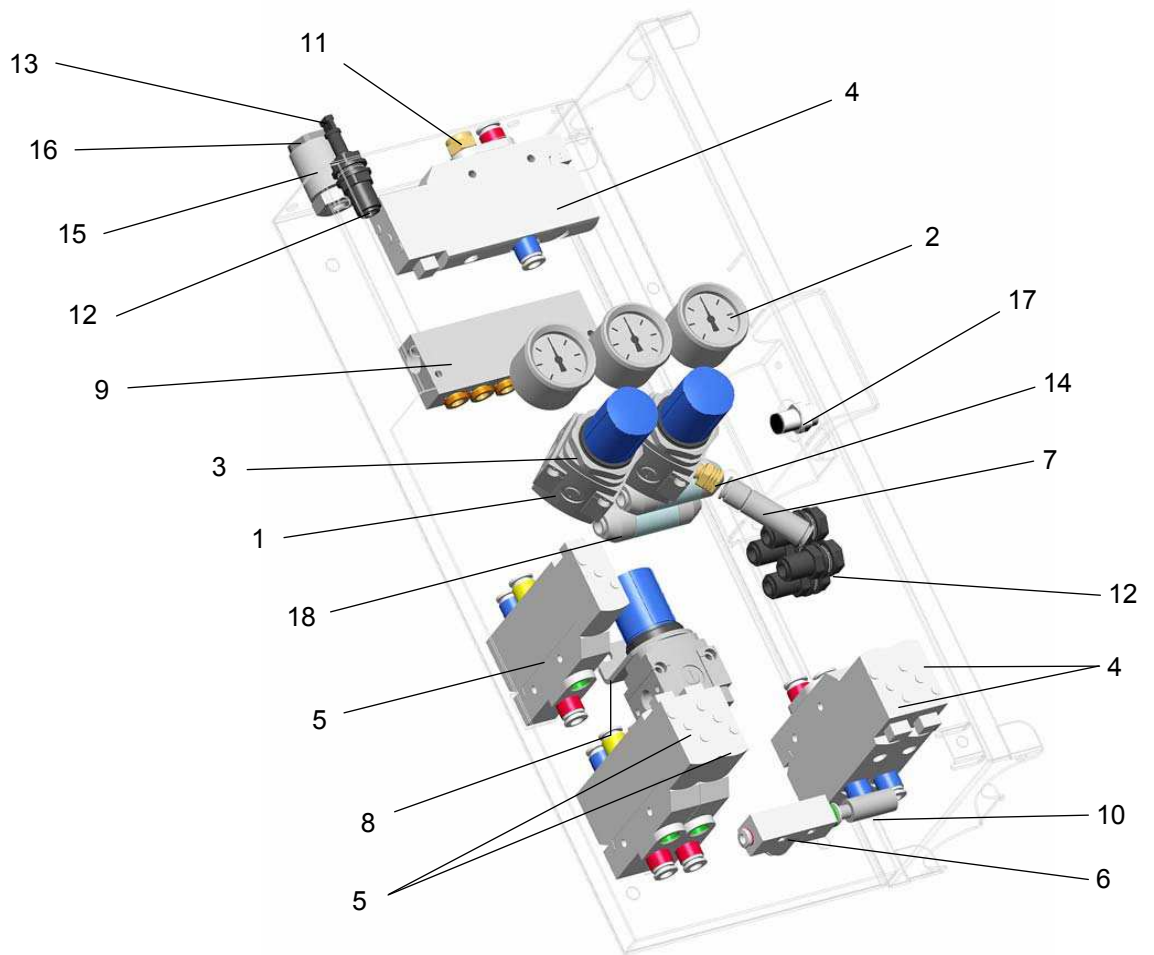

OptiFeed PP05 Powder pump - pneumatic group

OptiFeed PP05 Powder pump - pump control unit

	Pump control unit - complete	1003 091
1	Mains cable (Schuko)	382 485
	Mains cable (CH)	382 493
	Mains cable (USA)	382 507
	Mains cable (GB)	382 515
	Mains cable (AUS)	382 523
	Mains cable - 4 pins, for using a PLC	390 119
	PLC connecting cable - L=5 m (not shown)	1003 651
	PLC connecting cable - L=30 m (not shown)	1004 112
2	Protection cap	1003 372
3	Protection cap for connector socket	206 474
4	Protection cap for plug	206 458
5	Fuse - 2 AT	221 872
6	PP05 power pack connection	1003 371
7	Locknut - M3	262 498
8	Washer - Ø 3.2/7x0.5 mm	201 944
9	Spacer sleeve - Ø 3.2/6x0.6 mm, plastic	1000 590
10	Countersunk-head screw - M3x16 mm	263 419
11	OptiFeed PP05 front foil	1003 113
12	OptiFeed PP05 electronic board	1003 093
13	Power pack - 100-240 VAC / 24 VDC	1003 100
14	Socket cable - L=0.7 m	1003 297
15	Grounding cable - complete, L=5m (not shown)	301 140
16	OptiFeed PP05 short instruction (not shown)	1003 574
17	Cable lead-through	258 865
	Connection cable for LM02 Level sensor - L=6 m (not shown)	1003 229

OptiFeed PP05 Powder pump - pump control unit

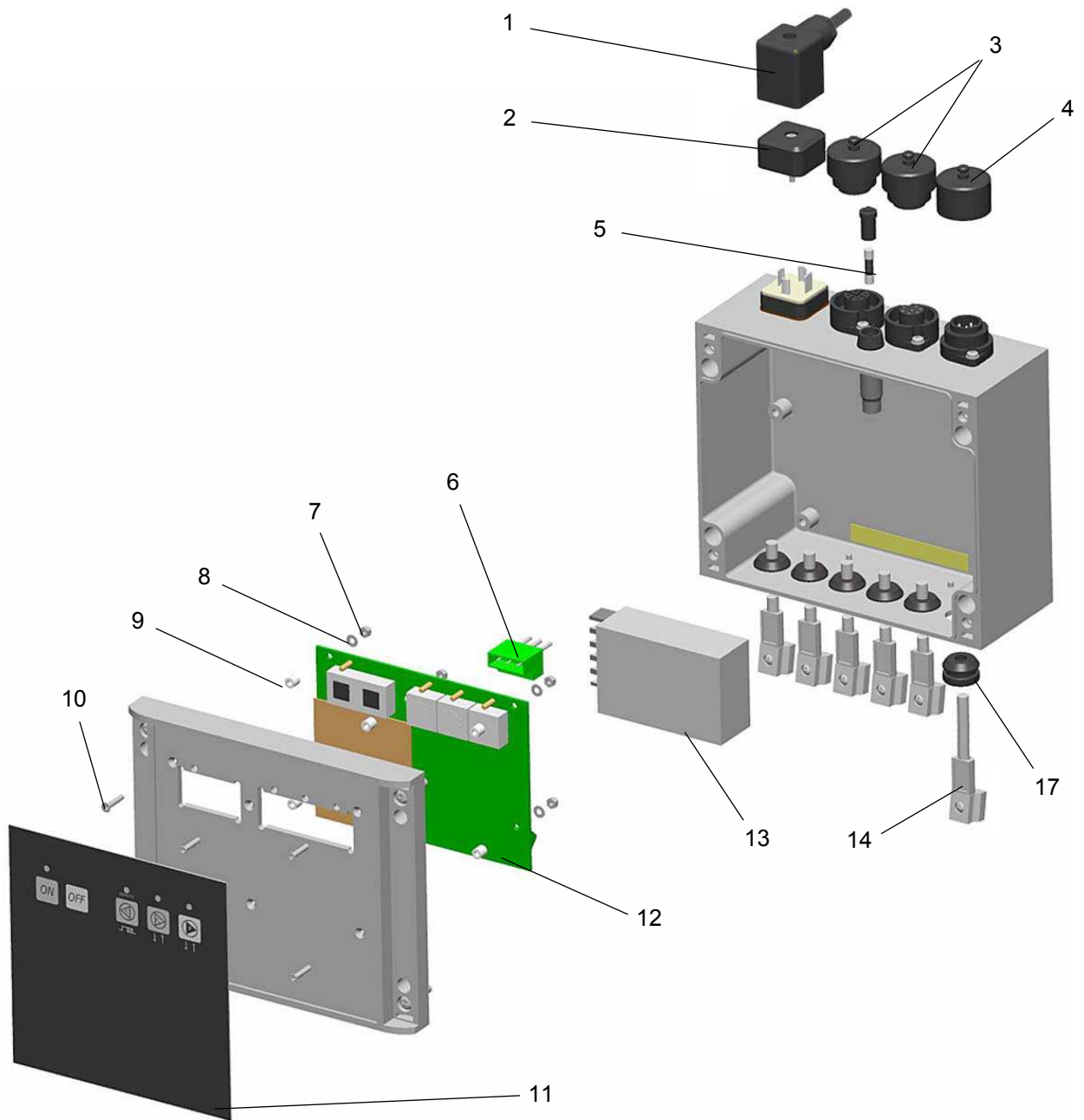

OptiFeed PP05 Powder pump - pump control unit

OptiFeed PP05 Powder pump - powder chamber

	Powder chamber - 40/30 mm, complete (pos. 1-13)	1003 007
1	Tube - 40/30 mm	1003 004
2	Filter element - 40/30 mm	1002 876#
3	Cone connection - 40/30 mm	1003 005
4	Threaded sleeve - M56x3 mm	1003 006
5	O-ring - Ø 30x3 mm, FKM75	1003 533#
6	O-ring - Ø 42x3 mm, FKM75	1003 534#
	Pinch valve - NW15, complete (pos. 8, 9, 10 and 11)	1003 304
8	Pinch valve body - NW15	1003 549
9	Pinch valve cover - NW15	1003 550
10	Pinch valve hose - NW15	1003 548#
11	PT-screw	1003 558
12	Elbow joint - 1/4", Ø 8 mm	254 029
13	Screw-in nipple - 1/4", Ø 8 mm	265 136
14	Y-piece - complete with hose connections Ø 15 mm (pos. 15 and 16)	1003 302
15	Y-piece	1003 303
16	Hose connection - Ø 15 mm	1003 301
17	Hose clamp - 17-25 mm	223 085
18	Powder hose - Ø 16/23 mm, L=100 mm	1003 307
19	T-piece - Ø 8 mm	230 987
20	Compressed air hose - Ø 8/6 mm	103 500*
21	Y-piece - complete with hose connection Ø 12 mm (pos. 16 and 22)	1004 346
22	Hose connection - Ø 12 mm	1003 308
	Powder hose suction side - Ø 12/18 mm (not shown)	1001 674
	Powder hose transport side - Ø 16/23 mm (not shown)	1003 307
	Maintenance set for PP05 Powder pump (not shown)	1003 947

* Please indicate length

Wearing part

OptiFeed PP05 Powder pump - powder chamber

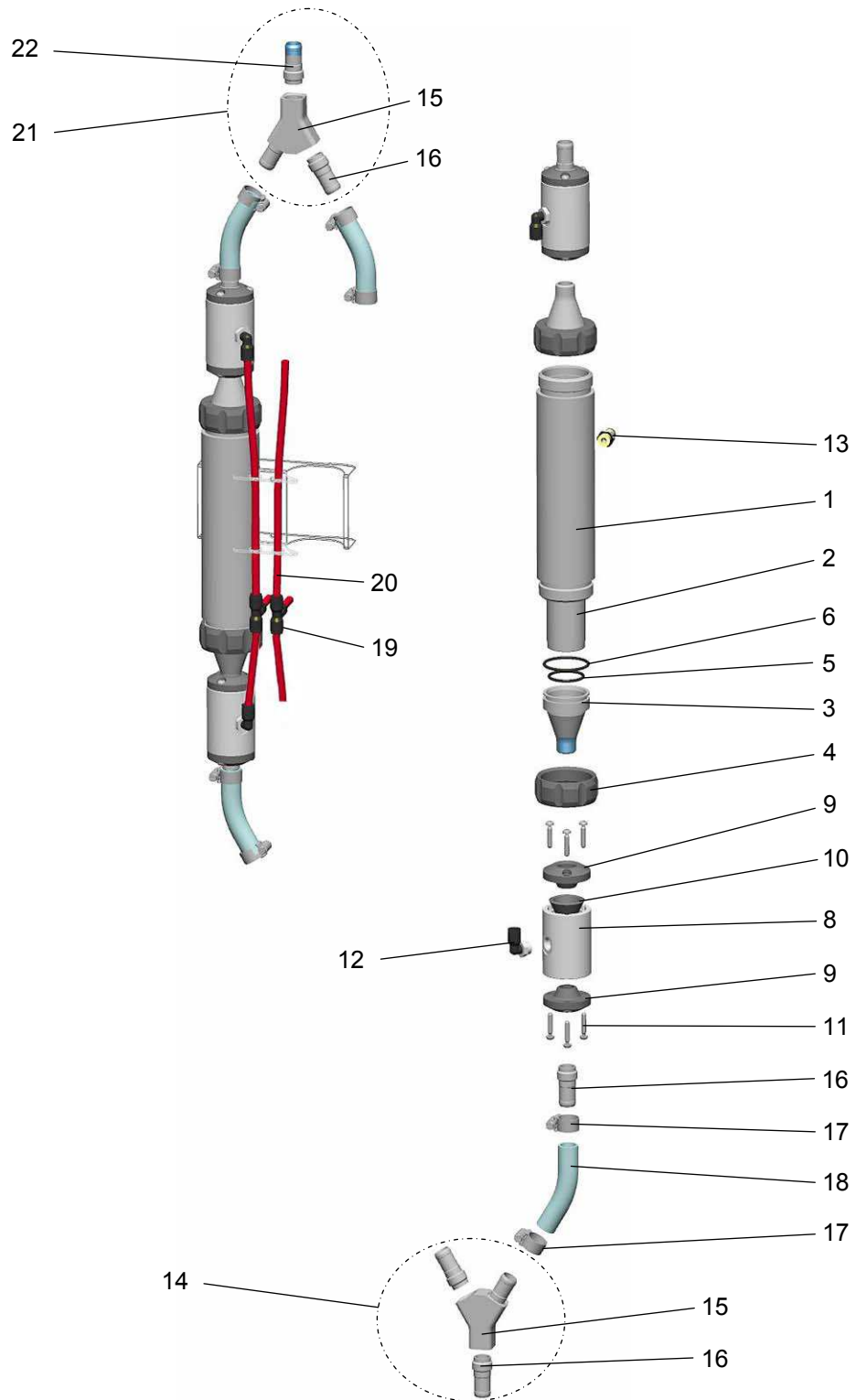

OptiFeed PP05 Powder pump - powder chamber