Operating instructions and spare parts list

OptiSelect Manual powder gun



Translation of the original operating instructions

Documentation OptiSelect manual powder gun

© Copyright 2006 Gema Switzerland GmbH

All rights reserved.

This publication is protected by copyright. Unauthorized copying is prohibited by law. No part of this publication may be reproduced, photocopied, translated, stored on a retrieval system or transmitted in any form or by any means for any purpose, neither as a whole nor partially, without the express written consent of Gema Switzerland GmbH.

OptiTronic, OptiGun, EasyTronic, EasySelect, OptiFlow and SuperCorona are registered trademarks of Gema Switzerland GmbH.

OptiMatic, OptiMove, OptiMaster, OptiPlus, MultiTronic and Gematic are trademarks of Gema Switzerland GmbH.

All other product names are trademarks or registered trademarks of their respective holders.

Reference is made in this manual to different trademarks or registered trademarks. Such references do not mean that the manufacturers concerned approve of or are bound in any form by this manual. We have endeavored to retain the preferred spelling of the trademarks, and registered trademarks of the copyright holders.

To the best of our knowledge and belief, the information contained in this publication was correct and valid on the date of issue. Gema Switzerland GmbH makes no representations or warranties with respect to the contents or use of this publication and reserves the right to revise this publication and make changes to its content without prior notice.

Printed in Switzerland

Gema Switzerland GmbH
Mövenstrasse 17
9015 St. Gallen
Switzerland

Phone: +41-71-313 83 00

Fax.: +41-71-313 83 83

E-Mail: info@gema.eu.com

Homepage: www.gemapowdercoating.com

Table of contents

General safety regulations	3
Safety symbols (pictograms).....	3
Conformity of use	3
Technical safety regulations for stationary electrostatic powder spraying equipment.....	4
General information	4
Safety conscious working.....	5
Individual safety regulations for the operating firm and/or operating personnel.....	5
Notes on special types of hazard	6
Safety requirements for electrostatic powder coating	7
A summary of the rules and regulations.....	8
Product specific safety precautions.....	9
About this manual	11
General information.....	11
Function description	13
Field of application	13
Typical characteristics	13
Scope of delivery	14
OptiSelect manual powder gun	14
OptiSelect manual powder gun	14
Structure	14
High voltage generation	15
Circuit	15
Powder flow and rinsing air	15
Remote control by gun	15
Spray nozzles.....	16
Standard-Set	16
Nozzle 150 mm	16
Nozzle 300 mm	16
Flat jet nozzle with vented central electrode	17
Round jet nozzle with vented deflector and vented central electrode.....	17
SuperCorona kit	18
Field of application	18
Scope of delivery.....	18
SuperCorona assembly.....	19
Technical Data	21
OptiSelect manual powder gun	21
Electrical data.....	21
Start-up and operation	23
Connecting guide	23
Function check	24

Start-up	25
Switch on the control unit.....	25
Maintenance and cleaning	27
Daily maintenance	27
Weekly maintenance.....	27
Cleaning.....	27
Cleaning the OptiSelect manual powder gun	27
Cleaning the spray nozzles.....	28
Dismantling the gun	29
Dismantling the gun	29
Replacing the powder gun cable	31
Assembling the gun	32
Replacing parts	32
Troubleshooting guide	33
General information	33
Spare parts list	35
Ordering spare parts	35
OptiSelect manual powder gun - spare parts list	36
Remarks.....	36
OptiSelect manual powder gun - spare parts list	37
OptiSelect manual powder gun - spare parts list (cont.).....	38
OptiSelect manual powder gun - nozzle combinations.....	39
OptiSelect manual powder gun - SuperCorona	40
OptiSelect manual powder gun - accessories	41
OptiSelect flat jet nozzles - overview	41
OptiSelect round jet nozzles - overview.....	42
OptiSelect gun extensions and SuperCorona	43
Powder hoses - overview.....	44
Powder hose connectors - overview.....	45
Miscellaneous parts	46

General safety regulations

This chapter sets out the fundamental safety regulations that must be followed by the user and third parties using the OptiSelect manual powder gun.

These safety regulations must be read and understood before the OptiSelect manual powder gun is used.

Safety symbols (pictograms)

The following warnings with their meanings can be found in the operating instructions. The general safety precautions must also be followed as well as the regulations in these operating instructions.

**DANGER!**

danger due to live electricity or moving parts. Possible consequences: Death or serious injury

**WARNING!**

Improper use of the equipment could damage the machine or cause it to malfunction. Possible consequences: minor injuries or damage to equipment

**INFORMATION!**



useful tips and other information

Conformity of use

1. The OptiSelect manual powder gun is built to the latest specification and conforms to the recognized technical safety regulations. It is designed for the normal application of powder coating.
2. Any other use beyond this is not intended. The manufacturer is not responsible for any damage resulting from this; the risk for this is carried by the user alone. If the OptiSelect manual powder gun is to be used for other purposes or other substances outside of our guidelines then Gema Switzerland GmbH should be consulted.
3. Observance of the operating, service and maintenance instructions specified by the manufacturer is also part of the conformity

of use. The OptiSelect manual powder gun should only be used, maintained and started up by trained personnel who are informed about and are familiar with the possible hazards involved.

4. The start-up (i.e. the execution of a particular operation) is forbidden until it has been established that the OptiSelect manual powder gun has been set up and wired according to the guidelines for machinery (98/37/EG). EN 60204-1 (machine safety) must also be observed.
5. Unauthorized modifications to OptiSelect manual powder gun exempts the manufacturer from any liability from resulting damage.
6. The relevant accident prevention regulations, as well as other generally recognized safety regulations, occupational health and structural regulations, are to be observed.
7. Furthermore, the country-specific safety regulations must be observed.

Explosion protection	Protection type	Temperature class
  II 2 D	IP64	T6 (gun)

Technical safety regulations for stationary electrostatic powder spraying equipment

General information

The powder spraying equipment from Gema is designed with safety in mind and is built according to the latest technological specifications. This equipment can be dangerous if it is not used for its specified purpose. Consequently it should be noted that there exists a danger to life and limb of the user or third party, a danger of damage to the equipment and other machinery belonging to the user and a hazard to the efficient operation of the equipment.

1. The powder spraying equipment should only be started up and used once the operating instructions have been carefully studied. Improper use of the controlling device can lead to accidents, malfunction or damage to the control itself.
2. Before every start-up check the equipment for operational safety (regular servicing is essential)!
3. Safety regulations BGI 764 and VDE regulations DIN VDE 0147, Part 1, must be observed for safe operation.
4. Safety precautions specified by local legislation must be observed.
5. The plug must be disconnected before the machine is opened for repair.
6. The plug and socket connection between the powder spraying equipment and the mains network should only be taken out when the power is switched off.
7. The connecting cable between the controlling device and the spray gun must be set up so that it cannot be damaged during

operation. Safety precautions specified by local legislation must be observed!

8. Only original Gema spare parts should be used, because the explosion protection will also be preserved that way. Damage caused by other parts is not covered by guarantee.
9. If Gema powder spraying equipment is used in conjunction with machinery from other manufacturers then their safety regulations must also be taken into account.
10. Before starting work familiarize yourself with all installations and operating elements, as well as with their functions! Familiarization during operation is too late!
11. Caution must be exercised when working with a powder/air mixture! A powder/air mixture in the right concentration is flammable! Smoking is forbidden in the entire plant area!
12. As a general rule for all powder spraying installations, persons with pacemakers should never enter high voltage areas or areas with electromagnetic fields. Persons with pacemakers should not enter areas with powder spraying installations!



WARNING!

We emphasize that the customer himself is responsible for the safe operation of equipment. Gema is in no way responsible for any resulting damages!

Safety conscious working

Each person responsible for the assembly, start-up, operation, service and repair of powder spraying equipment must have read and understood the operating instructions and the "Safety regulations"-chapter. The operator must ensure that the user has had the appropriate training for powder spraying equipment and is aware of the possible sources of danger.

The control units for the spray guns must only be set up and used in zone 22. The spray guns are permitted in the zone 21 created by them.

The powder spraying equipment should only be used by trained and authorized personnel. This applies to modifications to the electrical equipment, which should only be carried out by a specialist.

The operating instructions and the necessary closing down procedures must be followed before any work is carried out concerning the set-up, start-up, operation, modification, operating conditions, mode of operation, servicing, inspection or repairs.

The powder spray equipment can be turned off by using the main switch or failing that, the emergency shut-down. Individual components can be turned off during operation by using the appropriate switches.

Individual safety regulations for the operating firm and/or operating personnel

1. Any operating method which will negatively influence the technical safety of the powder spraying equipment is to be avoided.
2. The operator should care about no non-authorized personnel works on the powder spraying equipment (e.g. this also includes using the equipment for non-conform work).

3. For dangerous materials, the employer has to provide an operating instructions manual for specifying the dangers arising for humans and environment by handling dangerous materials, as well as the necessary preventive measures and behavior rules. The operating instructions manual has to be written in an understandable form and in the language of the persons employed, and has to be announced in a suitable place in the working area.
4. The operator is under obligation to check the powder spraying equipment at least once every shift for signs of external damage, defects or changes (including the operating characteristics) which could influence safety and to report them immediately.
5. The operator is obliged to check that the powder spraying equipment is only operated when in satisfactory condition.
6. As far as it is necessary, the operating firm must ensure that the operating personnel wear protective clothing (e.g. facemasks).
7. The operating firm must guarantee cleanliness and an overview of the workplace with suitable instructions and checks in and around the powder spraying equipment.
8. No safety devices should be dismantled or put out of operation. If the dismantling of a safety device for set-up, repair or servicing is necessary, reassembly of the safety devices must take place immediately after the maintenance or repair work is finished. The powder spraying device must be turned off while servicing is carried out. The operator must train and commit the responsible personnel to this.
9. Activities such as checking powder fluidization or checking the high-voltage spray gun etc. must be carried out with the powder spraying equipment switched on.

Notes on special types of hazard

Power

It is necessary to refer once more to the danger of life from high-voltage current if the shut-down procedures are not observed. High voltage equipment must not be opened - the plug must first be taken out - otherwise there is danger of electric shock.

Powder

Powder/air mixtures can be ignited by sparks. There must be sufficient ventilation in the powder coating booth. Powder lying on the floor around the powder spraying device is a potentially dangerous source of slipping.

Static charges

Static charges can have the following consequences: Charges to people, electric shocks, sparking. Charging of objects must be avoided - see "Earthing".

Grounding/Earthing

All electricity conducting parts and machinery found in the workplace (according to DIN VDE 0745, part 102) must be earthed 1.5 meters either side and 2.5 meters around each booth opening. The earthing resistance must amount to maximally 1 MOhm. The resistance must be tested on a regular basis. The condition of the machinery surroundings as well as the

suspension gear must ensure that the machinery remains earthed. If the earthing of the machinery includes the suspension arrangements, then these must constantly be kept clean in order to guarantee the necessary conductivity. The appropriate measuring devices must be kept ready in the workplace in order to check the earthing.

Compressed air

When there are longer pauses or stand-still times between working, the powder spraying equipment should be drained of compressed air. There is a danger of injury when pneumatic hoses are damaged and from the uncontrolled release and improper use of compressed air.

Crushing and cutting

During operation, moving parts may automatically start to move in the operating area. It must be ensured that only instructed and trained personnel go near these parts. The operator should ensure that barriers comply with the local security regulations.

Access under exceptional circumstances

The operating firm must ensure that local conditions are met when repairs are made to the electronic parts or when the equipment is restarted so that there are additional measures such as barriers to prevent unauthorized access.

Prohibition of unauthorized conversions and modifications to machines

All unauthorized conversions and modifications to electrostatic spraying equipment are forbidden for safety reasons.

The powder spraying equipment should not be used if damaged, the faulty part must be immediately replaced or repaired. Only original Gema replacement parts should be used. Damage caused by other parts is not covered by guarantee.

Repairs must only be carried out by specialists or in Gema workshops. Unauthorized conversions and modifications may lead to injury or damage to machinery. The Gema Switzerland GmbH guarantee would no longer be valid.

Safety requirements for electrostatic powder coating

1. This equipment is dangerous if the instructions in this operating manual are not followed.
2. All electrostatic conductive parts, in particular the machinery within 5 meters of the coating equipment, must be earthed.
3. The floor of the coating area must conduct electricity (normal concrete is generally conductive).
4. The operating personnel must wear electricity conducting footwear (e.g. leather soles).
5. The operating personnel should hold the gun with bare hands. If gloves are worn, these must also conduct electricity.
6. The supplied earthing cable (green/yellow) must be connected to the earthing screw of the electrostatic powder spraying hand appliance. The earthing cable must have a good metallic connec-

tion with the coating booth, the recovery unit and the conveyor chain and with the suspension arrangement of the objects.

7. The electricity and powder supply to the hand guns must be set up so that they are fully protected against heat and chemical damage.
8. The powder coating device may only be switched on once the booth has been started up. If the booth cuts out then the powder coating device must be switched off.
9. The earthing of all electricity conducting devices (e.g. hooks, conveyor chains) must be checked on a weekly basis. The earthing resistance must amount to maximally 1 MOhm.
10. The control device must be switched off if the hand gun is cleaned or the nozzle is changed.
11. When working with cleaning agents there may be a risk of hazardous fumes. The manufacturers instructions must be observed when using such cleaning agents.
12. The manufacturers instructions and the applicable environmental requirements must be observed when disposing of powder lacquer and cleaning agents.
13. If any part of the spray gun is damaged (broken parts, tears) or missing then it should not be used.
14. For your own safety, only use accessories and attachments listed in the operating instructions. The use of other parts can lead to risk of injury. Only original Gema replacement parts should be used.
15. Repairs must only be carried out by specialists and under no circumstances should they be carried out in the operating area. The former protection must not be reduced.
16. Conditions leading to dangerous levels of dust concentration in the powder spraying booths or in the powder spraying areas must be avoided. There must be sufficient technical ventilation available, to prevent a dust concentration of more than 50% of the lower explosion limit (UEG) (UEG = max. permissible powder/air concentration). If the UEG is not known then a value of 10 g/m³ should be used.

A summary of the rules and regulations

The following is a list of relevant rules and regulations which are to be observed:

Guidelines and regulations, German professional association

BGV A1	Prevention principles
BGV A3	Electrical equipment and material
BGI 764	Electrostatic coating
BGR 132	Guidelines for the avoidance of the dangers of ignition due to electrostatic charging (guideline "Static Electricity")
VDMA 24371	Guidelines for electrostatic coating with synthetic powder ¹⁾ - Part 1 General requirements - Part 2 Examples of use

EN European standards

RL94/9/EC	The approximation of the laws of the Member States relating to apparatus and safety systems for their intended use in potentially explosive atmospheres
EN 12100-1 EN 12100-2	Machine safety ²⁾
EN IEC 60079-0	Electrical equipment for locations where there is danger of explosion ³⁾
EN 50 050	Electrical apparatus for potentially explosive atmospheres - electrostatic hand-held spraying equipment ²⁾
EN 50 053, part 2	Requirements for the selection, installation and use of electrostatic spraying equipment for flammable materials - hand-held electrostatic powder spray guns ²⁾
EN 50 177	Stationary electrostatic spraying equipment for flammable coating powder ²⁾
EN 12981	Coating plants - spray booths for application of organic powder coating material - safety requirements
EN 60 529, identical: DIN 40050	IP-Type protection: contact, foreign bodies and water protection for electrical equipment ²⁾
EN 60 204 identical: DIN VDE 0113	VDE regulations for the setting up of high voltage electrical machine tools and processing machines with mains voltages up to 1000 V ³⁾

VDE (Association of German Engineers) Regulations

DIN VDE 0100	Regulations for setting-up high voltage equipment with mains voltages up to 1000 V ⁴⁾
DIN VDE 0105 part 1 part 4	VDE regulations for the operation of high voltage equipment ⁴⁾ General regulations Supplementary definitions for stationary electrical spraying equipment
DIN VDE 0147 part 1	Setting up stationary electrostatic spraying equipment ⁴⁾
DIN VDE 0165	Setting up electrical equipment in locations in areas with danger of explosion ⁴⁾

*Sources:

¹⁾ Carl Heymanns Verlag KG, Luxemburger Strasse 449, 5000 Köln 41, or from the appropriate employers association

²⁾ Beuth Verlag GmbH, Burgrafenstrasse 4, 1000 Berlin 30

³⁾ General secretariat, Rue Bréderode 2, B-1000 Bruxelles, or the appropriate national committee

⁴⁾ VDE Verlag GmbH, Bismarckstrasse 33, 1000 Berlin 12

Product specific safety precautions

- The installation work, to be done by the customer, must be carried out according to local regulations
- Before starting up the plant, check if no foreign objects are in the booth or in the ducting (input and exhaust air)
- It must be observed, that all components of the plant are grounded according to the local regulations

About this manual

General information

This operating manual contains all the important information which you require for the working with the OptiSelect manual powder gun. It will safely guide you through the start-up process and give you references and tips for the optimal use of your new powder coating system.

Information about the function mode of the individual system components - booth, gun control unit, manual gun or powder injector - should be referenced to their corresponding documents.

Function description

Field of application

The OptiSelect manual powder gun is built exclusively for the electrostatic coating with organic powders. Any other use beyond this is not intended. The manufacturer is not responsible for any damage resulting from this; the risk for this is assumed by the user alone!

The extremely light OptiSelect manual powder gun with integrated high voltage generation can produce optimum penetration and high charging efficiency. The patented vented central electrode allows a high, constant transfer efficiency and a high coating efficiency. The gun is detachable, therefore easy for maintenance and repair.

Typical characteristics

- Ergonomic construction
- Weight-optimized (520 gr.) with solid construction
- Gun balanced to reduce hand fatigue during coating operation
- Hermetically sealed construction, no powder penetration
- Powder tube integrated in the gun body with knee piece resistant to wear and powder depositions
- Remote control increases coating flexibility by independent adjustment of the application parameters
- Powder hose quick release connector with grounding connection
- Integrated high voltage cascade
- Integrated electrode rinsing air
- Grounded, ergonomic gun handle
- Easy one finger guided trigger
- Nozzles and extensions are compatible with OptiGun automatic gun and EasySelect manual powder gun
- The OptiSelect manual powder gun can be disassembled easily and is maintenance and repair-friendly
- Optional extension with SuperCorona kit

Scope of delivery

OptiSelect manual powder gun

- An OptiSelect manual powder gun with gun cable, 6 m
- Rinsing air hose, 6 m
- Flat jet nozzle, complete
- Round jet nozzle with deflector kit (Ø 16, 24 and 32 mm)
- Cable binder with Velcro closure
- Gun cleaning brush
- Spare parts kit

OptiSelect manual powder gun

Structure

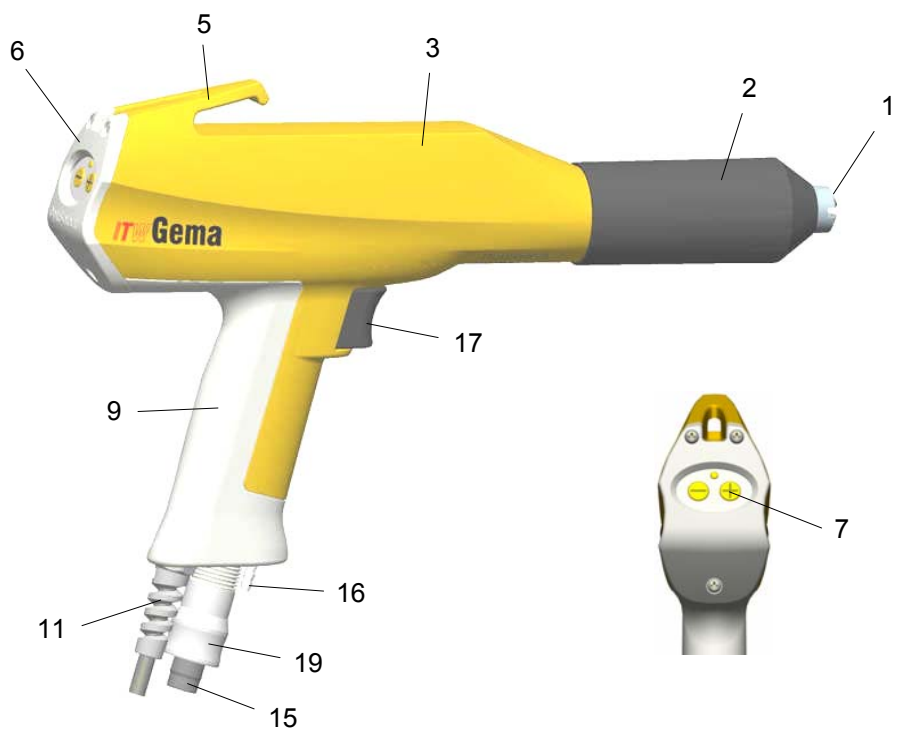

- | | | | |
|---|------------------------------|----|--------------------------------------|
| 1 | Spray nozzle | 9 | Gun handle |
| 2 | Threaded sleeve | 11 | Gun cable |
| 3 | Gun body | 15 | Powder hose connection |
| 5 | Mounting hook (exchangeable) | 16 | Rinsing air connection |
| 6 | Cover with remote control | 17 | Trigger |
| 7 | Remote control keys | 19 | Powder hose quick release connection |

High voltage generation

The control unit supplies a high-frequency low-voltage signal of approximately 10 V rms. This voltage is fed through the gun cable (11) to the high voltage cascade (4) in the gun body.

In the high voltage cascade (4), the low-voltage is high-transformed in a first step (c). This primary high voltage is subsequently rectified and multiplied in the high voltage cascade in a second step (d), until the required high voltage is obtained at the end (approx. 100 kV). The high voltage is now fed to the electrode within the spray nozzle (e).

Circuit

In addition to the modulated low voltage needed for high voltage generation, there are signal lines fed through the gun cable. The control signals are used for monitoring gun trigger status and gun remote control functions.

The gun is released by a reed switch, which is operated by a magnet in the trigger (17). The control unit switches the modulated low voltage, powder conveying, and the rinsing air on.

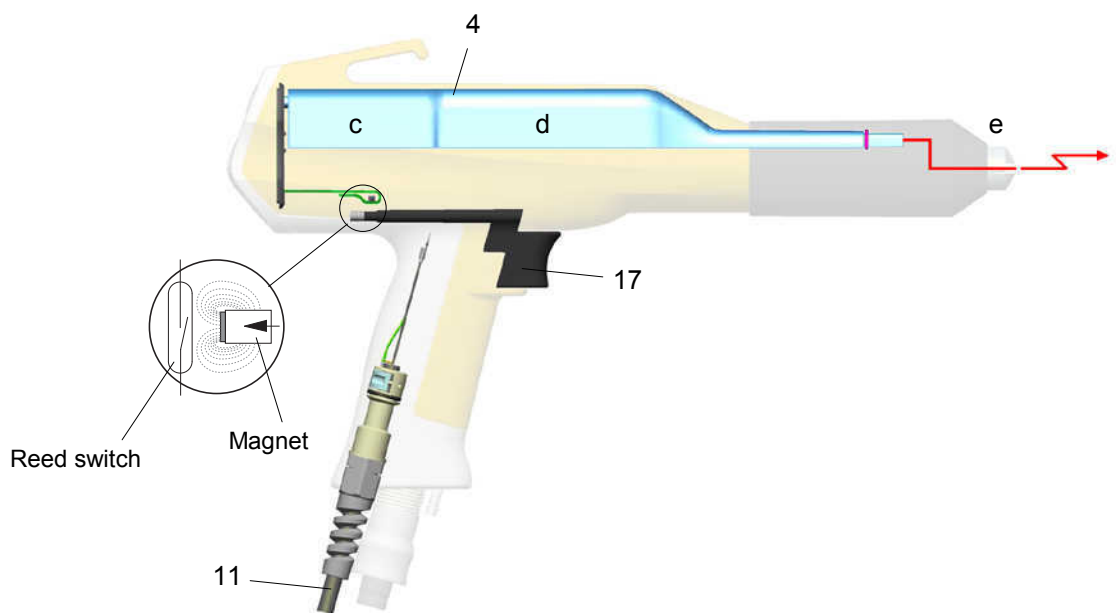

OptiSelect manual powder gun - circuit

Powder flow and rinsing air

The rinsing air, used by the vented spray nozzle, is connected with its designated connection on the rear of the gun control unit (see operating instructions of the powder gun control unit). The functions of the spray nozzles are described in the corresponding section of this manual.

Remote control by gun



Various functions can be remotely controlled with the + and - keys on the rear side of the powder gun (OptiSelect gun type):

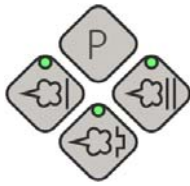

- Modify the powder output (press the + or - key on the gun). The powder output will be increased or decreased accordingly. The keys only change the value of powder output (in%)
- Change application modes (Preset and Program Mode) by pressing the + and - keys on the gun at the same time. The change takes place counterclockwise. Check by observing the key LEDs on the control unit



Note:

By pressing one of the keys, the preset values will be displayed versus the actual values!

Spray nozzles

Standard-Set

Flat jet nozzle with vented central electrode

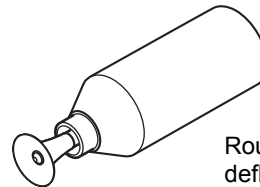
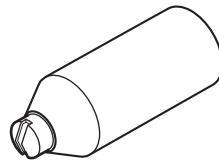

Round jet nozzle with deflector and vented central electrode

Nozzle 150 mm

(not part of the standard set, available separately, see spare parts list)

Extended flat jet nozzle with vented central electrode

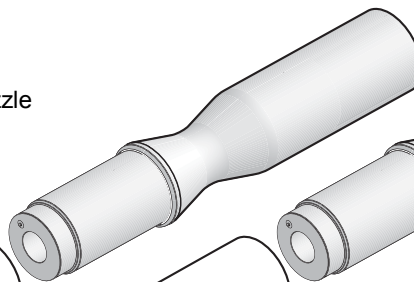
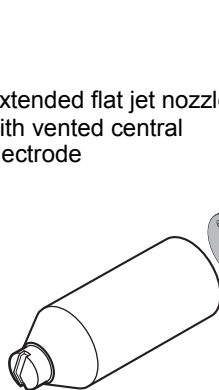

Extended round jet nozzle with vented deflector and vented central electrode

Nozzle 300 mm

not shown (not part of the standard set, available separately, see spare parts list)

Flat jet nozzle with vented central electrode

The vented flat jet nozzle serves for atomizing and charging of the powder. The powder cloud obtains an oval spray pattern by the slot-shaped opening. The powder is charged by the central electrode. The high voltage, which is created in the gun cascade, is conducted through the black contact ring of the nozzle holder to the central electrode.

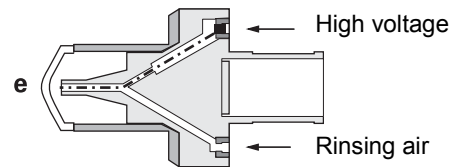

In order to prevent powder from sintering on the electrode, compressed air is used during the spray process. The compressed air (called rinsing air) is fed through the small hole in the black contact ring of the nozzle holder and into the electrode holder.

The rinsing air adjustment on the gun control unit is explained in the corresponding operating manual.

Round jet nozzle with vented deflector and vented central electrode

The vented deflector is used, to give the powder stream emerging from the gun, a cloud formation. The powder is charged by the central electrode. The high voltage, which is created in the gun cascade, is conducted through the black contact ring of the nozzle holder to the central electrode.

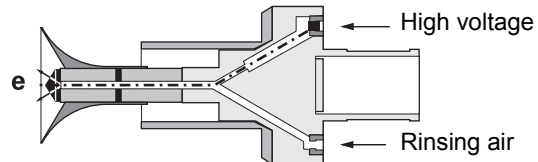

Since powder can accumulate on the rear side of the deflector, this must be rinsed with compressed air. The rinsing air is fed through the small hole in the black contact ring of the nozzle holder into the electrode holder, and is driven in such a way, that it flows over the surface of the deflector rear side. The rinsing air cleaning ability depends on the powder and its sintering ability.

The rinsing air adjustment on the gun control unit is explained in the corresponding operating manual.

SuperCorona kit

Field of application

SuperCorona is an optional extension for the OptiSelect manual powder gun, which allows better surface quality when spraying with powder coating equipment.

When coating wheel rims, drawers, radiators, lamps etc. the surface quality is exceptional, also in places with higher coating layer requirements. By coating with several powder types, an "orange peel" finish can be completely avoided. By coating with structure powder, the "picture frame effect" is hardly visible.

The performance of the OptiSelect manual powder gun with SuperCorona is convincing due to its very good charging and very high deposition rate as well as an improved penetration in Faraday cages. The distance between nozzle and workpiece can be reduced to 100 mm without influencing the surface finish.



SuperCorona - retrofit

Due to its modular structure, the OptiSelect manual powder gun can be fast and easily extended with the light SuperCorona (approx. 60 g). With the additional SuperCorona ring attached to the OptiSelect gun it remains repair-friendly and easy for maintenance.

Scope of delivery

The SuperCorona conversion kit consists of:

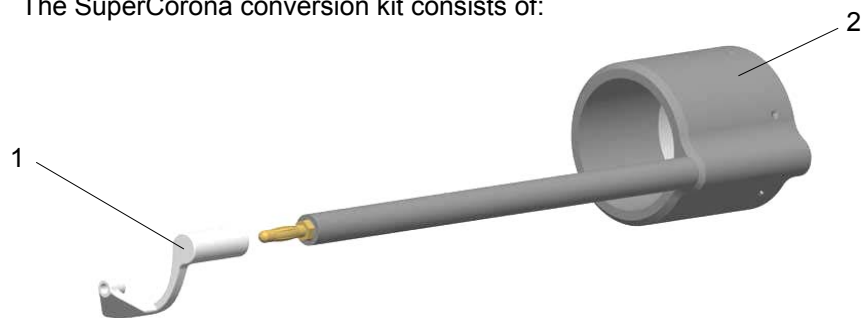

1 SuperCorona connection

2 SuperCorona ring

SuperCorona assembly

Before fitting the SuperCorona ring, make sure that the connection and the plug-in connector are free from grease and powder, otherwise the electric contact cannot be guaranteed.

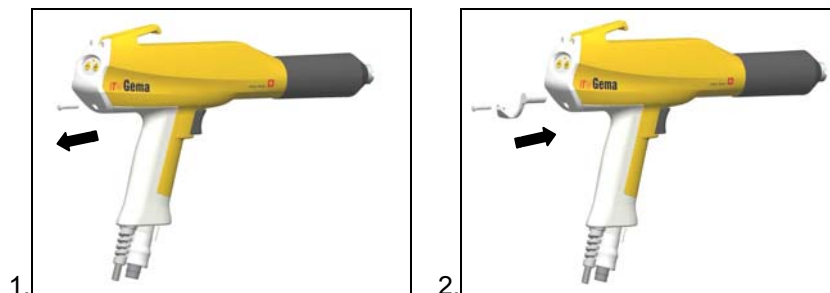

1.

2.

Fasten the SuperCorona connection with the existing screw on the rear side of the gun (1 and 2).

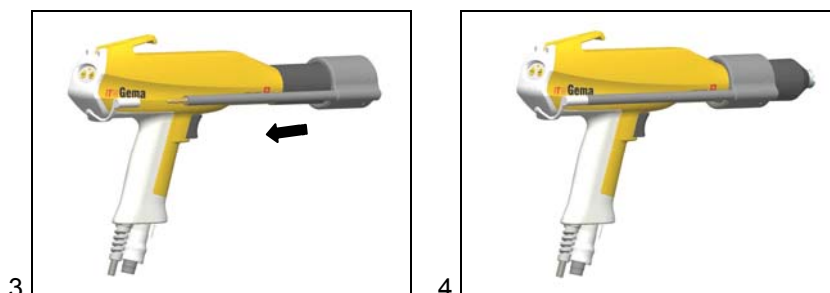

3.



4.

Insert the SuperCorona ring on the threaded sleeve (3) and connect it to the SuperCorona connection (4).

Technical Data

OptiSelect manual powder gun

Electrical data

OptiSelect manual powder gun	
Input voltage	10 V eff.
Frequency	approx. 18 kHz
Max. output voltage	100 kV
Polarity	negative (optional positive)
Max. output current	100 μ A
High voltage display	by LED
Ignition protection	Ex 2 mJ T6
Temperature range	0°C - +40°C (+32°F - +104°F)
Max. operating temperature	85°C (+185°F)
Approvals	  II 2 D PTB05 ATEX 5007



Attention:

The OptiSelect manual powder gun can be connected to the OptiStar and the OptiTronic (without remote control) control units!

Start-up and operation

Connecting guide



1. Connect the compressed air supply hose from the compressed air circuit directly to the filter unit main connection on the rear side of the equipment (connecting 1/4" BSP male thread). The compressed air connection from the filter unit to the control unit must be connected

Note:

The compressed air must be free from oil and water!

2. Connect the black hose for fluidizing air to the output **1.5** on the rear side of the control unit
3. Connect the grounding connection cable to the control unit with the grounding screw, and connect the 5 m long grounding cable with the clamping clip to the booth or the suspension device
4. Connect the gun cable plug to the socket **2.3** on the rear side of the control unit
5. Connect the rinsing air hose to the electrode rinsing air output **1.4** and to the powder gun
6. Attach the injector, connect the powder hose to the injector and to the powder gun
7. Connect the red hose for conveying air to the corresponding output **1.2** on the rear side of the control unit and to the injector
8. Connect the black hose for supplementary air to the corresponding output **1.3** on the rear side of the control unit and to the injector (this hose is electrically conductive)
9. Connect the mains cable to the plug **2.1 Power IN** and screw it on

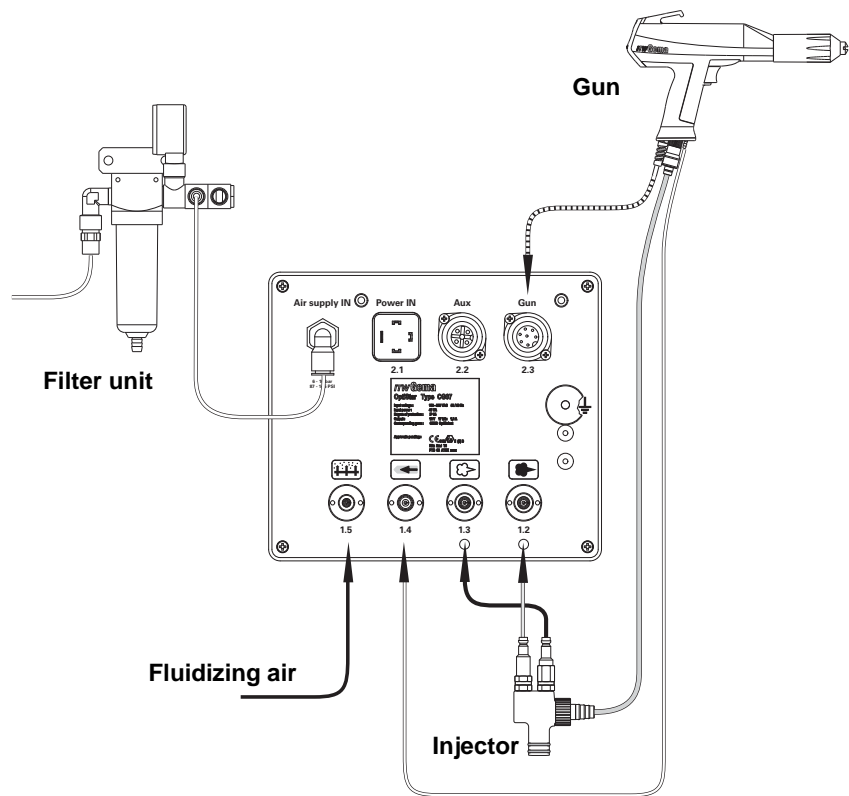

Connecting guide - overview

Function check

1. Turn on the gun control unit
2. Press the desired application key (Preset or Program Mode) on the control unit (see gun control unit operating instructions)
3. Pick the gun up and point it at a grounded object, at a distance of approx. 20 cm
4. Press the powder gun trigger
 - The display for current and high voltage on the control unit shows the actual value. The high voltage is present in the OptiSelect gun, and the LED illuminates
 - The high voltage can be set with the corresponding keys (See also the control unit operating instructions)
5. Select the powder output and total air volume
 - The display indicates the powder output in % and total air volume in m³/h
6. Press the corresponding key for the rinsing air on the control unit (according to the nozzle used)
7. Check the remote control by pressing the + or - key on the back of the powder gun, and the modified powder output value is displayed on the control unit. By simultaneous pressing of the + and - key, the application modes can be changed on the control unit

When all the checks are positive, the gun is ready for operation.



Note:

If a malfunction occurs, see the "Troubleshooting Guide" as well as the gun control operating manual!

Start-up

Switch on the control unit

1. Press the **ON** power switch on the control unit.
The displays illuminate and the control unit is ready for operation



Note:

The next procedure for starting-up the OptiSelect manual powder gun is explicitly described in the OptiStar CG07 control unit operating instructions (chapter "Initial start-up" and "Daily start up")!

Maintenance and cleaning



Note:

Regular and conscientious maintenance increases the operating life of the unit and ensures a longer, more constant coating quality!

Daily maintenance

1. Clean the gun, see chapter "Cleaning"

Weekly maintenance

1. Clean the gun, see chapter "Cleaning"
2. Check the grounding connections of the coating booth, the suspension devices of the work pieces, or the conveyor chain

Cleaning

Cleaning the OptiSelect manual powder gun

Frequent cleaning of the gun serves to guarantee the quality of the coating.



Note:

Before cleaning the powder gun, switch off its control unit. The compressed air used for cleaning must be free from oil and water!

Daily

1. Blow off the outside of the gun and wipe clean etc.

Weekly

2. Remove powder hose from connector
3. Remove the spray nozzle from the gun and clean it with compressed air
4. Blow through the gun with compressed air, beginning from the connection in flow direction

5. Clean the integrated gun tube with the supplied brush, if necessary
6. Blow through the gun again with compressed air
7. Clean the powder hose
8. Reassemble the gun and connect it

**Attention:**

Cleaning the OptiSelect manual powder gun with the following solvents is not allowed:

Ethylene chloride, acetone, ethyl acetate, methyl ethyl ketone, methylene chloride, premium gasoline, turpentine, tetrachloromethane, toluene, trichloroethylene, xylene!

**Note:**

Only cleaning agents with a flash point of a least 5 Kelvin above the ambient temperature, or cleaning places with technical ventilation are allowed!

Cleaning the spray nozzles

Daily or after every shift

- Clean the inside and outside of the spray nozzle with compressed air.
Never immerse the parts in solvents!
- Check the seating of the spray nozzles.
Make sure that the threaded sleeve is always tightened well. If the spray nozzle is not completely tight, the danger exists, that the high voltage of the gun can flash over, which can lead to damage to the powder gun!

Weekly

- Remove the spray nozzles and clean inside with compressed air. If sintering should have formed, then this is to be removed!

Monthly

- Check the spray nozzles for wear

The flat jet nozzle is to be replaced, if:

- the spray pattern is no longer a regular oval
- deeper grooves in the nozzle slot or even the wall thickness is no longer visible
- the wedge of the electrode holder is worn down

Nozzles with deflectors:

- if the wedge of the electrode holder is worn down, then the electrode holder is to be replaced

Dismantling the gun

The gun should only be dismantled when this is made necessary by a defect or contamination. It is only to be dismantled so far, as the desired part is accessible.



Attention:

The control unit must be switched off and the gun plug detached, before cleaning the gun!

If the cascade is defective or the shaft is broken, send the complete shaft to an authorized Gema service center!

Dismantling the gun

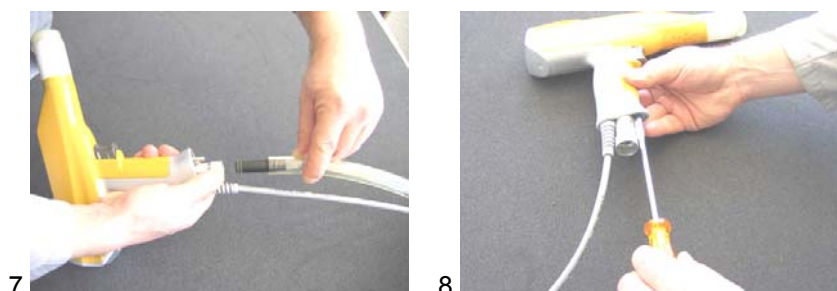
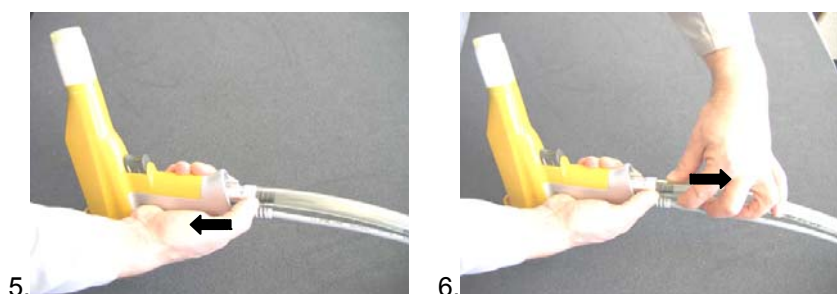
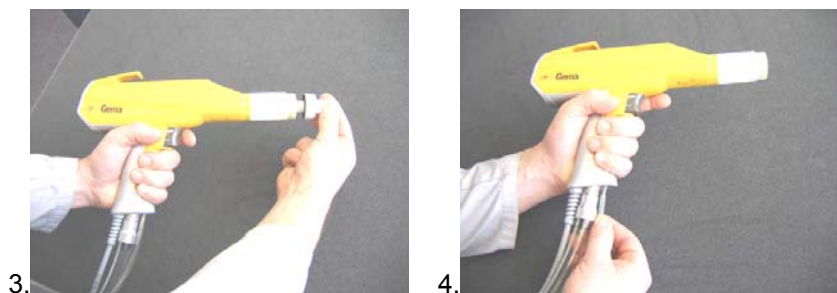
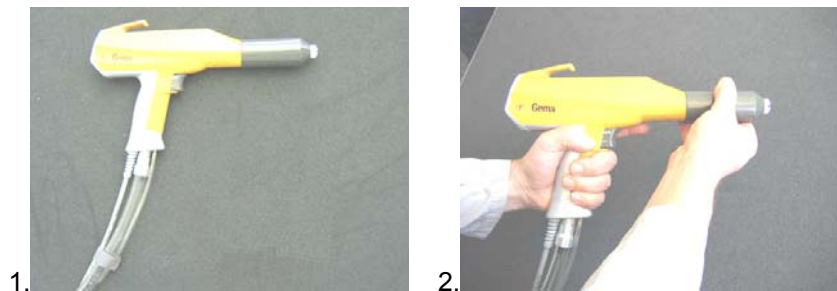



Replacing the powder gun cable

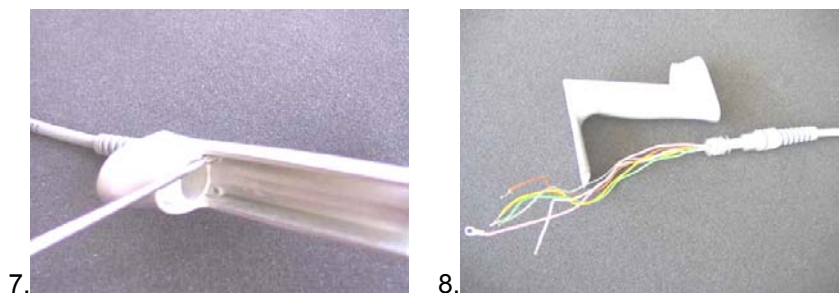
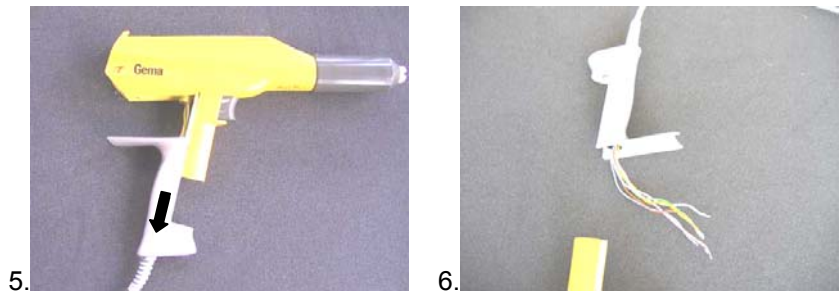
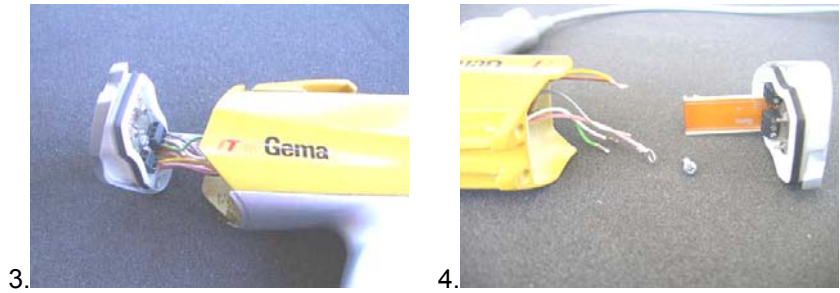
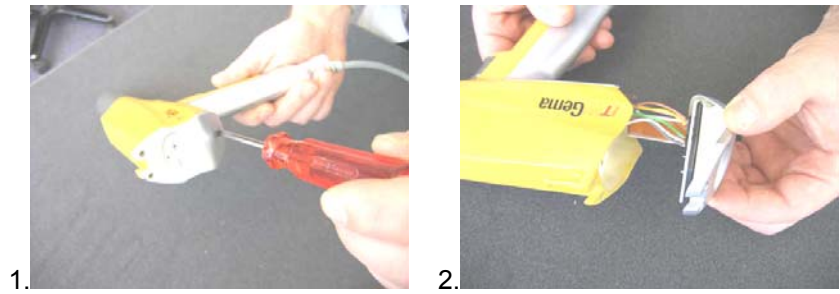

Assembling the gun

The assembly of the gun is carried out in the reverse order to that shown above.



Replacing parts

Except for the replacement of possible defective parts, there are very few repairs to be made. The replacement of the cascade, and the repair of the powder gun cable connection is only permitted by an authorized Gema repair center! Contact your Gema representative for details!

Troubleshooting guide

General information

Fault	Criteria	Solution
H11 (error message on control unit)	Gun not connected Gun plug or gun cable defective Remote control on powder gun defective	Connect the gun Replace corresponding part or send in for repair Replace remote control (gun cap)
Gun LED remains dark, although the gun is triggered	High voltage adjustment is set too low Gun plug or gun cable defective LED on gun defective	Increase high voltage Replace defective part or send in for repair Replace gun back cover
Powder does not adhere to object, although the gun is triggered and sprays powder	High voltage and current deactivated High voltage cascade defective Objects are not properly grounded	Check the high voltage and current setting Send in the gun for repair Check the grounding

Fault	Causes	Fault elimination
<p>The gun does not spray powder, although the control unit is switched on and the gun is triggered</p>	<p>Compressed air not present</p> <p>Too little conveying air</p> <p>Injector or nozzle on the injector, powder hose or powder gun clogged</p> <p>Insert sleeve in the injector worn or not inserted</p> <p>Nozzle in the injector clogged</p> <p>Fluidizing not running</p> <p>No conveying air:</p> <p>Motor throttle defective</p> <p>Solenoid valve defective</p> <p>Front plate defective</p>	<p>Connect the equipment to the compressed air</p> <p>Increase the powder output and/or total air volume on the control unit</p> <p>Clean corresponding part</p> <p>Replace or insert</p> <p>Replace</p> <p>(see above)</p> <p>Replace the motor throttle</p> <p>Replace the solenoid valve</p> <p>Send in for repair</p>

Spare parts list

Ordering spare parts

When ordering spare parts for powder coating equipment, please indicate the following specifications:

- Type and serial number of your powder coating equipment
- Order number, quantity and description of each spare part

Example:

- **Type** OptiSelect manual powder gun,
Serial number 1234 5678
- **Order no.** 203 386, 1 piece, Clamp - Ø 18/15 mm

When ordering cable or hose material, the required length must also be given. The spare part numbers of this yard/meter ware is always marked with an *.

The wear parts are always marked with a #.

All dimensions of plastic hoses are specified with the external and internal diameter:

Example:

Ø 8/6 mm, 8 mm outside diameter (o/d) / 6 mm inside diameter (i/d)



WARNING!

Only original Gema spare parts should be used, because the hazardous location approval will be preserved that way! The use of spare parts from other manufacturers will invalidate the Gema guarantee conditions!

OptiSelect manual powder gun - spare parts list

Remarks

1. If a part of the gun body should be broken, or the high voltage cascade in the gun body should be defective, then the whole gun body is to be sent in for repair and check!
2. If the powder gun cable is defective, it is to be completely sent in for repair!

A	OptiSelect manual powder gun - complete negative polarity , incl. gun cable - 6 m, rinsing air hose - 6 m, flat jet nozzle, brush and parts kit, without powder hose	1002 100
	OptiSelect manual powder gun - complete positive polarity , incl. gun cable - 6 m, rinsing air hose - 6 m, flat jet nozzle, brush and parts kit, without powder hose	1002 101
B	OptiSelect manual powder gun shaft (incl. cascade)	
	Negative polarity (-)	1001 891
	Positive polarity (+)	1001 892
C	Cascade (negative polarity) - complete	1000 809
	Cascade (positive polarity) - complete	1002 031
1	Gun body	1001 155
	Handle - complete set (pos. 5, 6, 7 and 8)	1000 807
2	Trigger - complete (incl. pos. 2 and 3)	1001 341
3	Compression spring - 0.36x4.2x49.4 mm	1001 487
4	Trigger cover	1000 801
5	Grasp termination	1000 806
6	Radial gasket	1000 803
7	Gun cable - L=6 m, complete	1001 528
	Extension cable for gun cable - L=6m, incl. safety clamp	1002 161
	Extension cable for gun cable - L=14m, incl. safety clamp	1002 162
	Safety clamp for extension cable	1002 064
8	Grub screw - M3x8 mm	1000 844
10	Powder tube - complete	1001 339
10.2	O-ring - Ø 12x1.5 mm	1000 822
11	Rinsing air connection	1000 804
12	Clip ring	1000 898
13	Compression spring	1001 488

OptiSelect manual powder gun - spare parts list (cont.)

14	Back cover - complete	1000 617
14.1	Printed circuit board holder - complete (incl. pos. 14.2)	1002 029
14.2	Radial gasket	1000 795
14.3	Shield - complete	1002 028
14.4	Cap screw - M3x8 mm (not shown)	202 363
15	Hose connection - complete, for internal hose Ø 11-12 mm	1001 340
	Hose connection - complete, for internal hose Ø 9-10 mm	1002 030
15.2	O-ring - Ø 12x1.5 mm	1000 822
16	Hook (replaceable)	1000 877
17	Countersunk head screw - M4x8 mm, plastic	263 516
18	PT-screw	1000 843
19	Threaded sleeve - complete	1000 948
20	Flat jet nozzle - complete	1000 047
20.1	Electrode holder - complete	1000 055
20.2	Flat jet nozzle	1000 049
	OptiSelect adaptor for PGC control unit (not shown)	1001 952
	Cleaning brush - Ø 12mm	389 765
	Parts set (not shown), consisting of:	1002 359
	Round jet nozzle - NS02, complete	382 922
	Cable clamp	303 070
	Deflector plate - Ø 16 mm	331 341
	Deflector plate - Ø 24 mm	331 333
	Deflector plate - Ø 32 mm	331 325
	Hose connection - complete, for internal hose Ø 11-12 mm	1001 340
	O-ring - Ø 12x1.5 mm	1000 822
	Countersunk head screw - M4x8 mm, plastic	263 516
	Powder hose - Ø 10 mm (not shown)	1001 673
	Powder hose - Ø 11 mm (not shown)	105 139

OptiSelect manual powder gun - nozzle combinations

	Nozzle set - flat jet, NF08, pos. 1, 2	1000 047#
	Nozzle set - round jet, pos. 5, 6, 9	382 922
1	Electrode holder (flat jet nozzle)	1000 055#
2	Flat jet nozzle	1000 049#
3	Threaded sleeve	1000 948
5	O-ring - \varnothing 5x1 mm	231 606#
6	Round jet nozzle	378 518#
7	Deflector - \varnothing 16 mm	331 341#
7.1	Deflector - \varnothing 24 mm	331 333#
7.2	Deflector - \varnothing 32 mm	331 325#
8	Extension - 150 mm	378 852#
8.1	Extension - 300 mm	378 860#
9	Electrode holder, incl. pos. 5 (round jet nozzle-central electrode)	382 914#

Wearing part

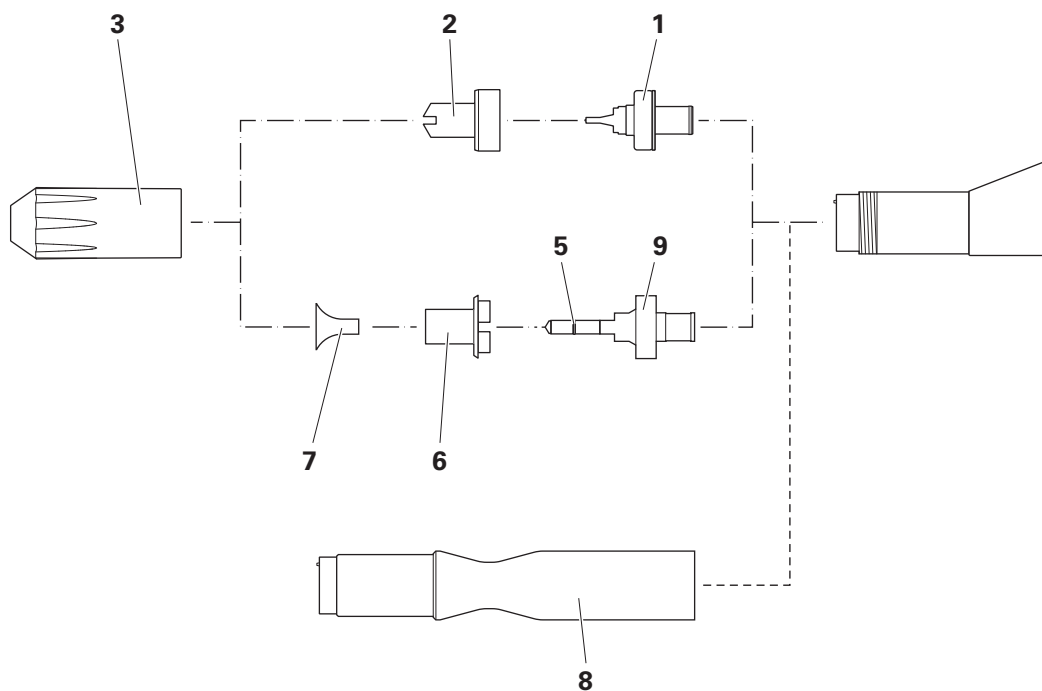

OptiSelect manual powder gun - nozzle combinations

OptiSelect manual powder gun - SuperCorona





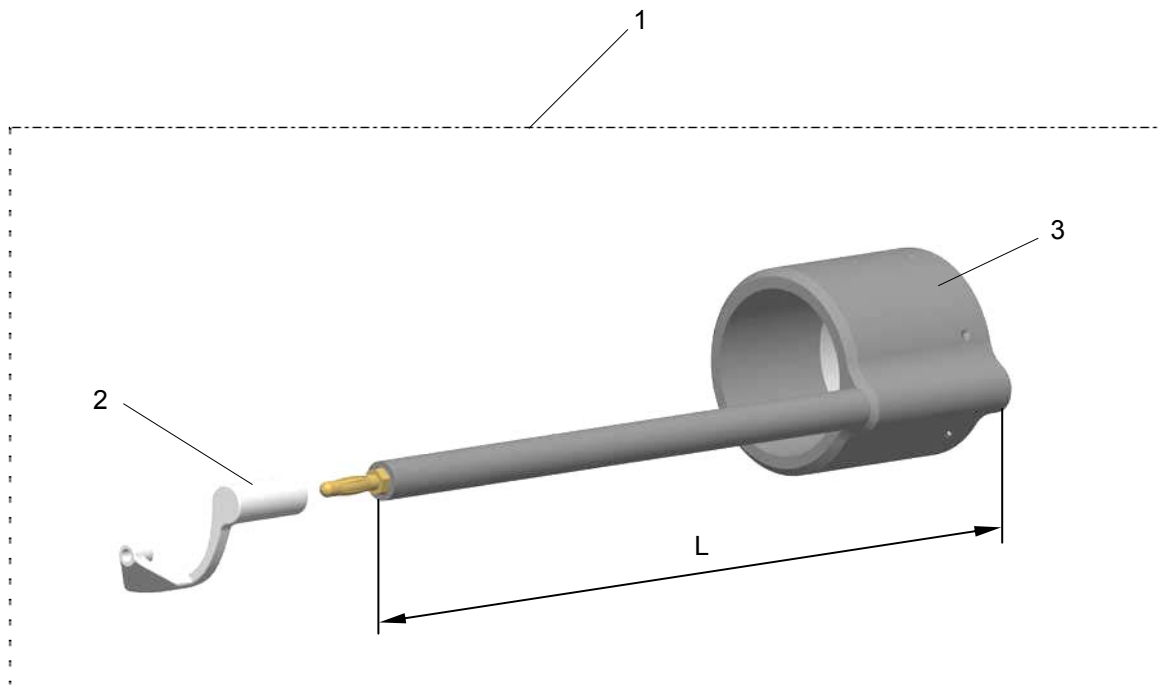



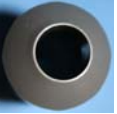

1	SuperCorona - complete set, without extension, L=215 mm	1002 066#
	SuperCorona - complete set, for extension 150 mm, L=365 mm	1002 067#
	SuperCorona - complete set, for extension 300 mm, L=515 mm	1002 068#
2	SuperCorona - connection	1001 466#
3	SuperCorona-Ring	391 980#
	SuperCorona-Ring, for extension version 150 mm	394 173#
	SuperCorona-Ring, for extension version 300 mm	394 203#

Wearing part



OptiSelect manual powder gun - accessories

OptiSelect flat jet nozzles - overview

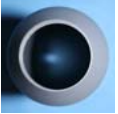





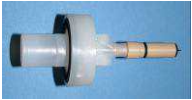
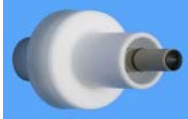
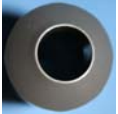
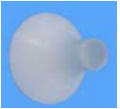







Application	A	B	A + B	Threaded sleeves	Multispray-Adapter
Profiles (Standard nozzle)	 NF08 1000 049	 NF09* 1000 118	NF08 1000 047	 1000 948	 1003 634*
			NF09 1000 119		
For custom design	 NF11 1000 122	 NF12 1000 124	NF11 1000 123	 1000 055	 1003 897*
For recess openings and cavities (deep)	 NF10 1000 120		NF12 1000 125		
Angled spray pattern (Boron Nitride)	 NF16-M* 1003 182		NF10 1000 121	 383 074	
Wide flat spray for large surface areas					
Flat jet nozzle for metallic powders					

* not type approved (ATEX)

OptiSelect round jet nozzles - overview

For large flat sur- face areas		NS02 378 518		382 914		NS02 382 922		1000 948		Deflectors	
										Ø 16 mm	331 341
										Ø 24 mm	331 333
										Ø 32 mm	331 325
									Ø 50 mm	345 822	



OptiSelect gun extensions and SuperCorona

Gun extensions		SuperCorona			
Ø 40 mm	L = 150 mm  378 852	L = 300 mm  378 860	L = 150 mm  1002 067	L = 300 mm  1002 068	 1001 466
			 394 173	 394 203	
Ø 25 mm Flat spray	 396 923	 396 931	 1003 519	 1003 520	
Ø 25 mm Deflector	 396 940	 396 958	 1003 142	 1003 143	

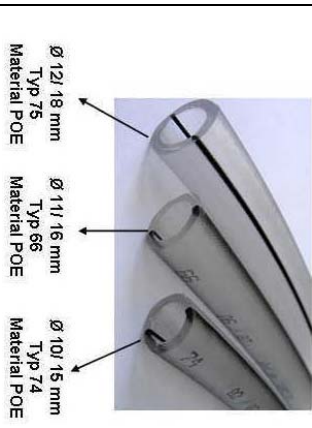
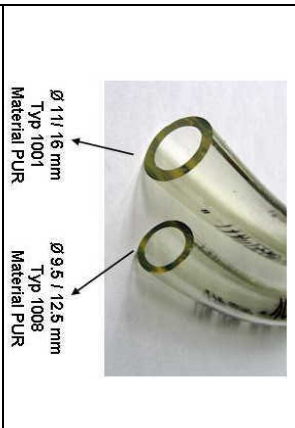
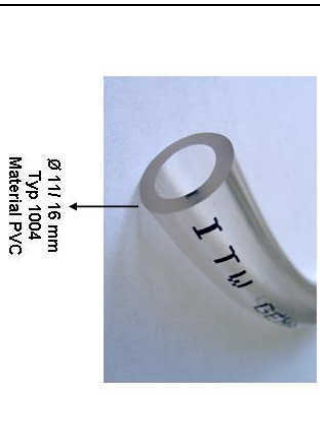





Powder hoses - overview

Powder hose	Application	Diameter	Part no.	Material	Type	Remarks
 <p> Ø 12/ 18 mm Typ 75 Material POE </p> <p> Ø 11/ 16 mm Typ 66 Material POE </p> <p> Ø 10/ 15 mm Typ 74 Material POE </p>	Fast color change (standard)	Ø 11/16 mm	105 139	POE	66	antistatic
	Fast color change - low powder flow	Ø 10/15 mm	1001 673	POE	74	antistatic
	Fast color change - high powder flow	Ø 12/18 mm	1001 674	POE	75	antistatic
 <p> Ø 11/ 16 mm Typ 1001 Material PUR </p> <p> Ø 9.5 / 12.5 mm Typ 1008 Material PUR </p>	Boron Nitride powder - low powder flow	Ø 9.5/12.5 mm	103 705	PUR	1008	special applications
	Used on previous equipment	Ø 11/16 mm	103 012	PUR	1001	special applications
 <p> Ø 11/ 16 mm Typ 1004 Material PVC </p>	Enamel powder	Ø 11/16 mm	103 128	PVC	1004	flexible powder hose
	Used on previous equipment	Ø 12/20 mm	100 080	PVC	1005	flexible powder hose

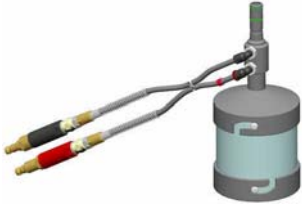
Powder hose connectors - overview

Powder hose connector	Application	Part no.	Remarks
	Hose connector for 9-10 mm hoses	1002 030	O-ring is included
	Hose connector for 11-12 mm hoses	1001 340	O-ring is included

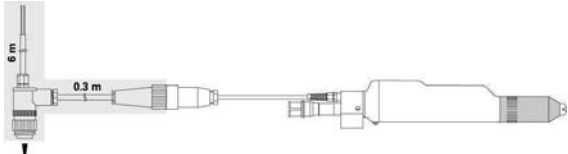
Miscellaneous parts

<p>Application cup</p>	<p>150 ml</p>  <p>1004 552</p>	<p>500 ml</p>  <p>1002 069</p>	<p>Adapter for EasySelect gun</p>  <p>1004 564</p>
<p>PGC Adapter</p>	<p>PGC Gun control ←  → OptiSelect gun</p> <p>1001 952</p>		
<p>Tribo-Corona Adapter</p>	 <p>1001 869</p>		
<p>Trigger adapter for automatic Guns</p>	 <p>OptiStar 1002 772</p>		
<p>Gun extension cable</p>	 <p>L=6 m 1002 161 L=14 m 1002 162</p>		
<p>Gloves, antistatic (1 pair)</p>	 <p>800 254</p>		

